

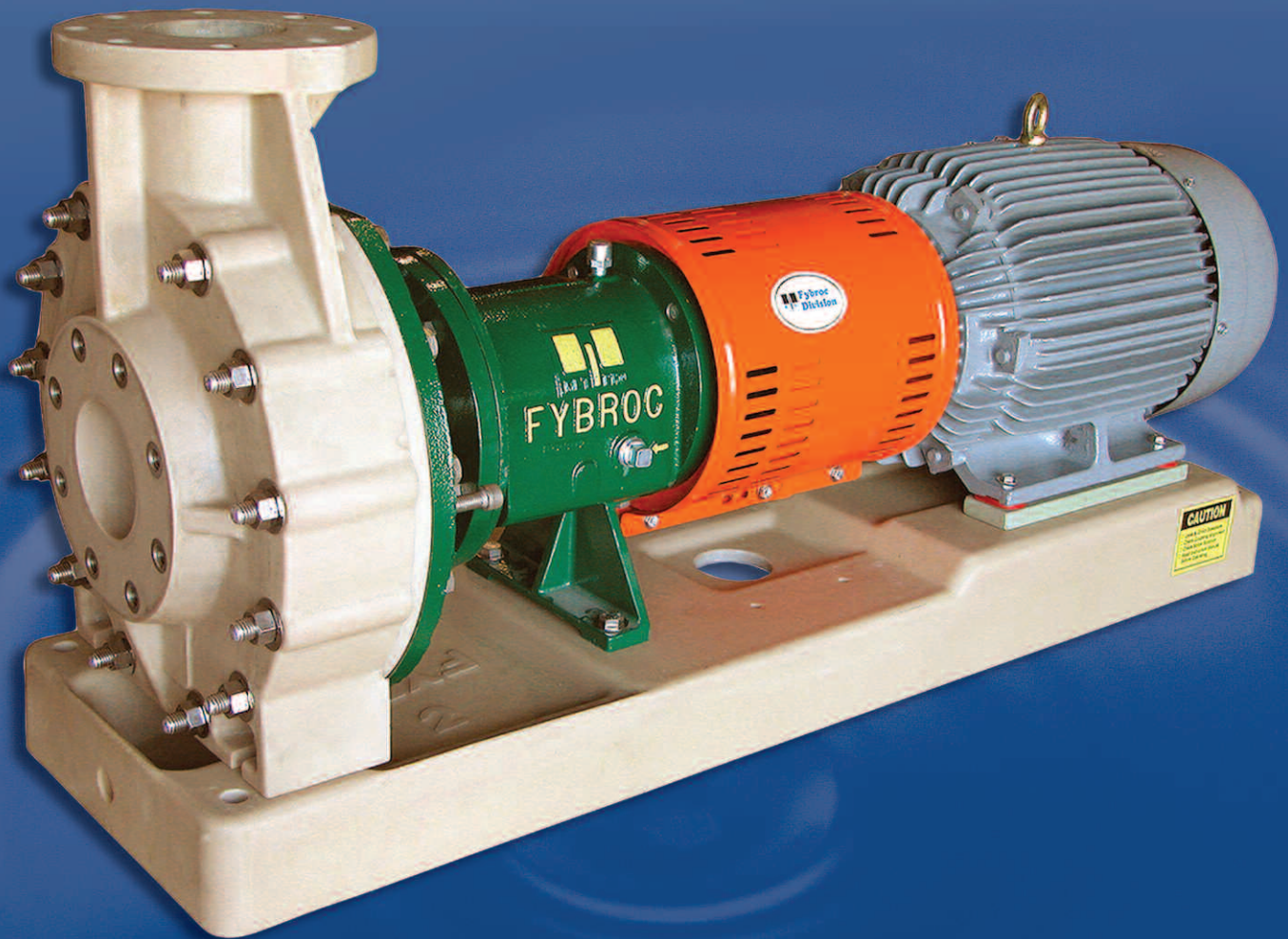

A Met-Pro Fluid Handling Technologies Business  
Combining the Resources of Dean Pump, Fybroc & Sethco

## FYBROC® SERIES 1500

ANSI/ASME SPECIFICATION B73.1



# Fybroc® Horizontal Fiberglass Pumps

BULLETIN 15B1



# FYBROC – THE LEADER IN CORROSION-RESISTANT FIBERGLASS PUMPING EQUIPMENT

Fybroc is an advanced technology pump manufacturer specializing in reinforced composite centrifugal pumps, designed to handle corrosive liquids.

Fybroc, the pioneer in the fiberglass pump field, continues its position of leadership with its Series 1500 pump. This line is the culmination of many years of

experience in producing high quality, corrosion-resistant pumps.

The Series 1500 combines an extensive knowledge of materials and production techniques to provide exceptional structural integrity, excellent corrosion resistance, and dependable service in difficult operating environments.

## MATERIALS OF CONSTRUCTION ARE AVAILABLE FOR A WIDE RANGE OF CORROSIVE LIQUIDS

Only Fybroc has the flexibility in materials selection to solve your difficult corrosive or abrasive pump problems.

- **VR-1**, vinyl ester resin: used for the vast majority of corrosive applications including most acids, caustics, brines, sea water, and wastewater.
- **VR-1 BPO-DMA**, vinyl ester resin with BPO-DMA cure system: used to accommodate applications for specific corrosion resistance to bleaches such as sodium hypochlorite (NaOCl) and hydrogen peroxide (H<sub>2</sub>O<sub>2</sub>).
- **VR-1A**, vinyl ester resin with abrasive resistant material: used for pumping liquids with low concentration highly abrasive fines such as fly ash, diatomaceous earth or titanium dioxide.
- **VR-1V**, vinyl ester resin with synthetic veil: protection used specifically for fluoridic applications such as hydrofluoric acid (HF) and fluosilicic acid (H<sub>2</sub>SiF<sub>6</sub>).
- **EY-2**, epoxy resin: offers outstanding chemical resistance for aggressive chemical/compounds, acids, and solvents. Ideal for high concentrations of sulfuric acid (up to 98%).

### FDA COMPLIANCE

The Dow DERAKANE series epoxy vinyl ester resin utilized by Fybroc, when properly formulated and cured, will comply with the U.S. Food, Drug, and Cosmetic Act, as amended, and applicable FDA regulations (21 CFR 177.2420). These resins may be used as articles or components of articles intended for repeated use in contact with food, subject to certain limitations described in that regulation.

For further information on corrosion resistance to specific chemicals, please refer to the Met-Pro Global Pump Solutions website at

[www.mp-gps.com](http://www.mp-gps.com).

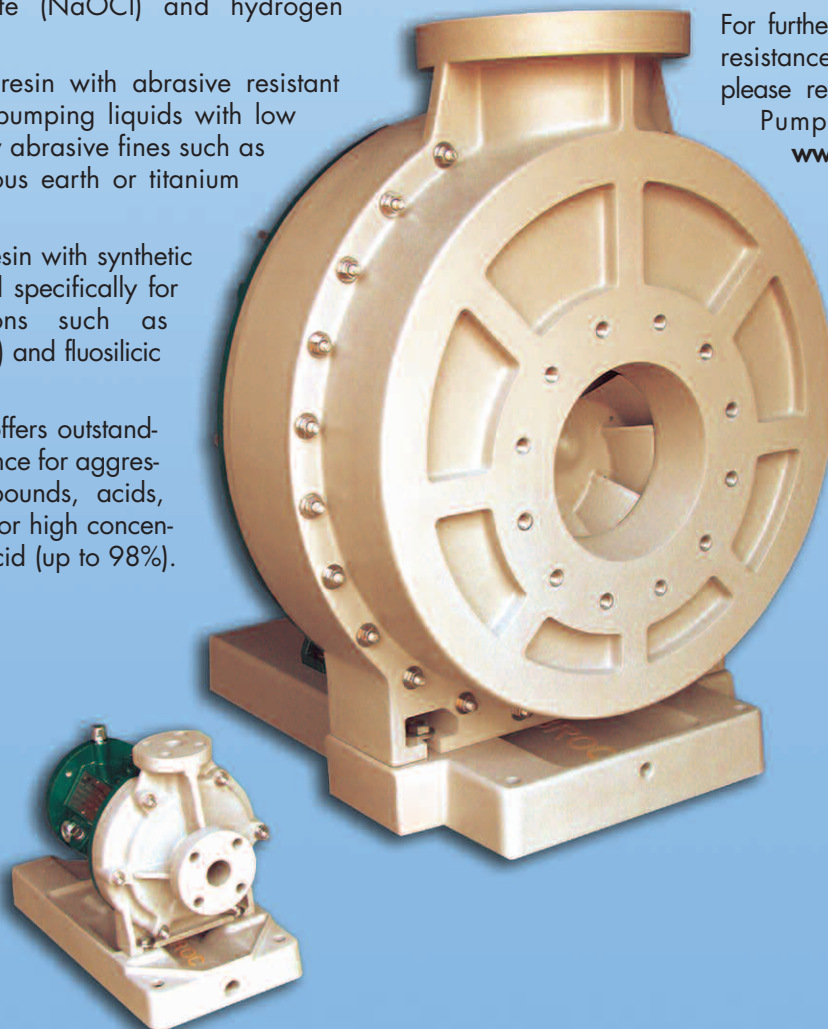

# FYBROC SERIES 1500 THERMOSET CONSTRUCTION RESIN TRANSFER MOLDING (RTM) PROCESS FOR SUPERIOR STRENGTH AND CORROSION RESISTANCE

Thermoset fiberglass reinforced plastic (FRP) pumps are increasingly being used in the pump industry due to their low weight, durability, and tailor-made properties. A thermoset is a material that cures or hardens (sets) into a given shape, generally through the reaction with a catalyst. Curing is an irreversible chemical reaction in which permanent connections (cross-links) are made between a material's molecular chains. The cross-links give the cured polymer a three-dimensional structure, as well as a higher degree of rigidity than it possessed prior to curing.

It is important to note that a thermoset material will not re-melt or otherwise regain the processibility it had before being cured. Thermoset materials outperform other materials (thermoplastics, for example) in a number of areas, including the following: mechanical properties, chemical resistance, thermal stability, and overall durability.

The fiberglass components in the Series 1500 Series pumps, as well as Fybroc's complete line of centrifugal pumps, utilize the Resin Transfer Molding process. This process allows for the controlled placement of continuous-strand fiberglass mat in high stress areas. Specifically, sheets of continuous-strand fiberglass mat are die cut into specific shapes and then loaded into matched-metal die molds. After loading, the molds are closed and then injected with catalyzed resin into a single inlet port with numerous vent ports to ensure complete air displacement. After the resin gels, the part is removed and allowed to cure at ambient temperature, and then the part is post-cured in a controlled heat operation. The major advantage of the RTM process, unlike a

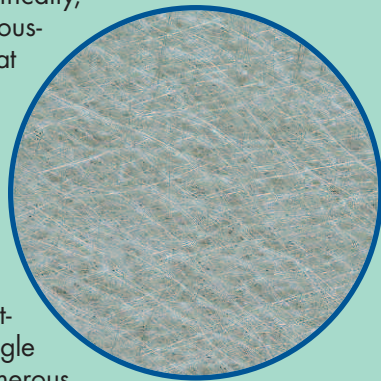

compression molded process that inherently utilizes randomly oriented pieces of chopped fiberglass leading to comparatively lower strength, is that the carefully oriented continuous-strand fiberglass mat provides components with excellent physical strength and properties. In addition, the process allows for the design of thinner-walled structures, thereby permitting the use of nearly pure resin systems for optimum corrosion resistance. The bottom line is that RTM is a manufacturing technique that optimizes both strength and corrosion resistance.

Critical components such as the single-piece casing, with its heavily gusseted suction and discharge flanges, benefit from the reinforcing properties of the RTM process. This permits the handling of normal pipe loads under full working pressures. Furthermore, this method of reinforcement in the impeller extends the life of this component and provides unparalleled strength without degradation in corrosive environments.

With more than thirty years of composite pump design and manufacturing experience, Fybroc has the expertise to provide you with a composite pump line of the highest quality and durability for your specific service or application. Remember, FRP pumps are our ONLY business! By controlling the entire manufacturing process in-house, Fybroc is able to offer flexibility with special customer requirements while boasting the best lead times in the industry.

## CORROSION-RESISTANT FIBERGLASS BASEPLATES

Fybroc manufactures fiberglass baseplates since chemical pumps are often used and installed in environments where external corrosion can be a serious problem. The

baseplates are constructed of fiberglass-reinforced vinyl ester resin utilizing continuous-strand reinforcement for maximum strength and stiffness. In addition, they accommodate ANSI/ASME dimensioned pumps (and NEMA/IEC motors) with an integral, sloped drip pan under the pump, a tapped drain connection, and a provision for a grouted foundation. Refer to page 13 for additional baseplate information and specifications.

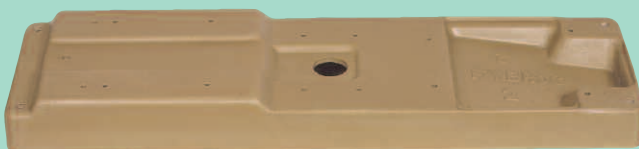

# DESIGN FEATURES OF THE FybROC SERIES 1500 PUMP

The Fybroc Series 1500 pump is designed for broad corrosion-resistance through the use of high quality materials and state-of-the-art engineering. Its simplicity and versatility make it the ideal choice for all demanding pumping requirements.

The fiberglass components are manufactured utilizing the Resin Transfer Molding technique which enables complete control of the fiberglass reinforcement in high stress areas. Metallic pump components are NOT in contact with process fluids.

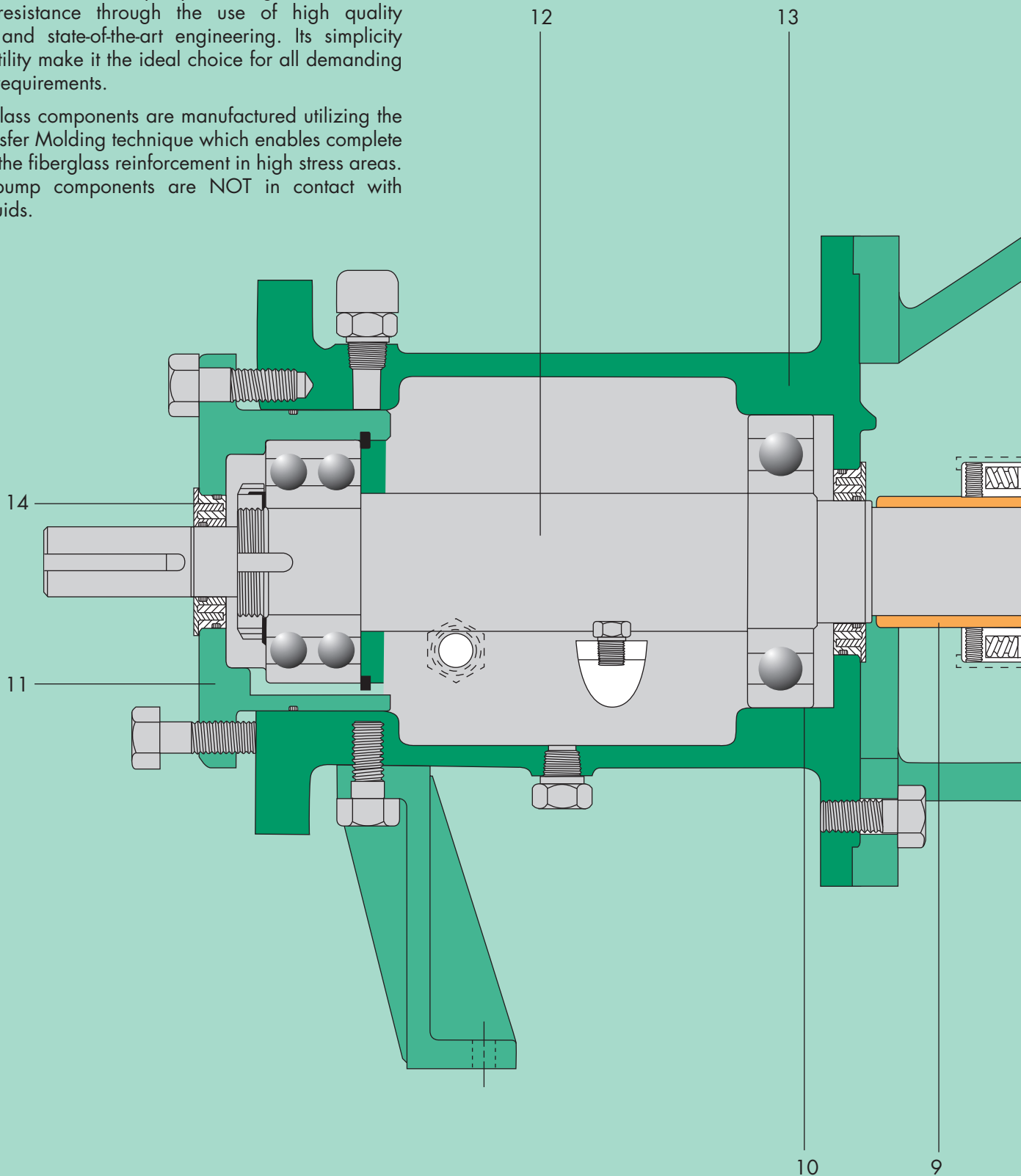

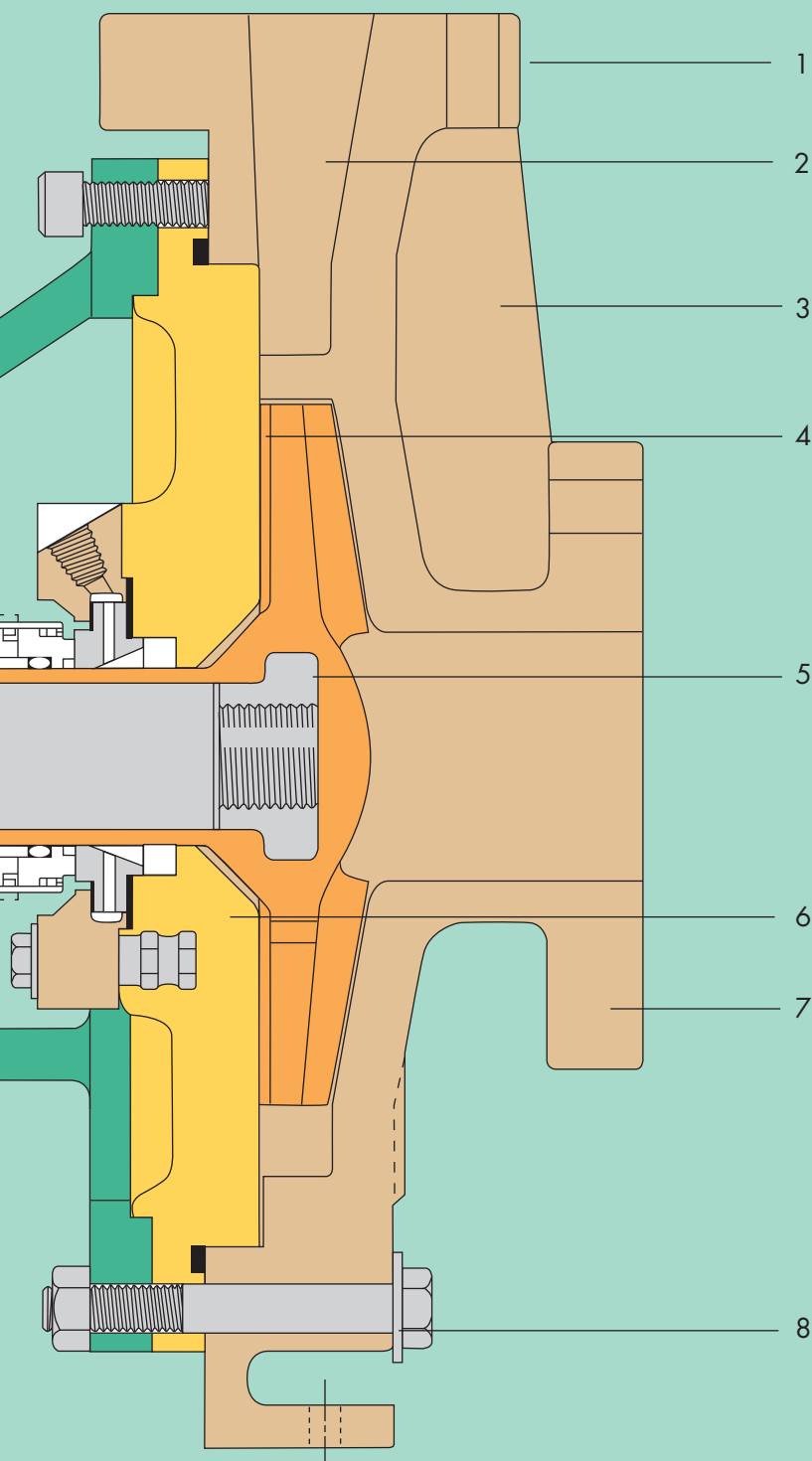

1. **ANSI/ASME B73.1 CONFORMANCE** ensures maximum interchangeability with existing metal ANSI pumps, thereby eliminating any need for piping or foundation changes when up-grading an installation to Fybroc Series 1500 pumps.
2. **SMOOTH HYDRAULIC PASSAGES** promote increased pump efficiency.
3. **SINGLE ONE-PIECE GUSSETED CASING** easily withstands the rigors of normal plant piping loads.
4. **IMPELLER PUMP-OUT VANES** and relief holes minimize axial unbalance and lower stuffing box pressure.
5. **ALLOY INSERT** (integrally molded with impeller) with rounded edges carries impeller torque loads with low stress.
6. **VERSATILE CASING COVER** is suitable for use with most single outside or double inside mechanical seals without modifications. See page 7 for some of the most frequently used configurations and page 8 for seal flush considerations.
7. **CONTINUOUS-STRAND FIBERGLASS CONSTRUCTION** for all wetted parts in either vinyl ester or epoxy resin provides maximum corrosion resistance for a wide range of difficult liquids.
8. **CASING THROUGH-BOLTS** maintain casing o-ring seal integrity under all hydraulic operating conditions.
9. **INTEGRAL SHAFT SLEEVE** design eliminates gaskets and o-rings and protects the pump shaft from exposure to the process fluid.
10. **LARGE-CAPACITY BEARINGS** ensure operating life well in excess of the minimum specified by ANSI/ASME B73.1.
11. **EXTERNAL IMPELLER ADJUSTMENT** allows field setting of impeller-to-casing clearance.
12. **HEAVY-DUTY SHAFT** minimizes deflection to maximize mechanical seal life.
13. **POLYESTER THERMOSETTING POWDER COATED POWER FRAME** components prevent external corrosion.
14. **LABYRINTH OIL SEALS** nickel plated-bronze for longer life. Improved oil containment.

# DESIGN PROVIDES FOR MAXIMUM SEAL AND BEARING LIFE

The Series 1500 pumps have been designed to maximize the life of bearings and mechanical seals which can deteriorate because of shaft deflection resulting from radial thrust. Radial thrust is the force acting on the side of an impeller as a result of the non-uniform distribution of pressure around the pump casing at off-peak operation.

The magnitude of this thrust varies with the flow, but the amount of radial thrust can roughly be cut in half by utilizing a double volute casing. The solid line in the chart to the right depicts the typical radial thrust characteristic of a single volute casing. The dotted line portrays the use of a double volute casing and the resulting reduction in radial thrust.

The drawing at lower right shows the location of the "cutwater" in volute casings. The cutwater is the close clearance extension of the casing located at the base of the volute. Also, shown in orange, is the second cutwater or "splitter" used in the double volute casing, which channels half of the flow to the pump discharge. The splitter reduces the pressure imbalance in the casing during off-peak flows and reduces both radial thrust and its resulting shaft deflection. Fybroc uses double volute casings in eleven of its larger pump sizes where, typically, radial thrust loadings are higher. See chart on page 9, Casing Data, Volute.

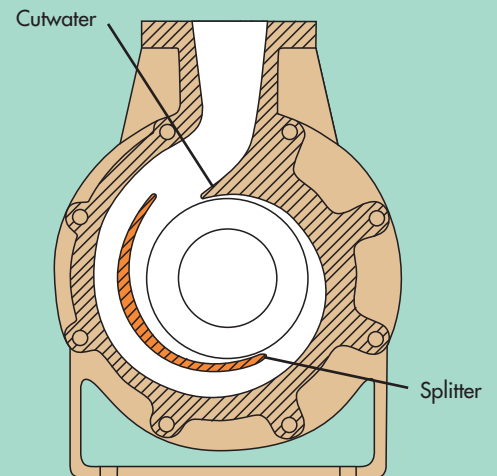
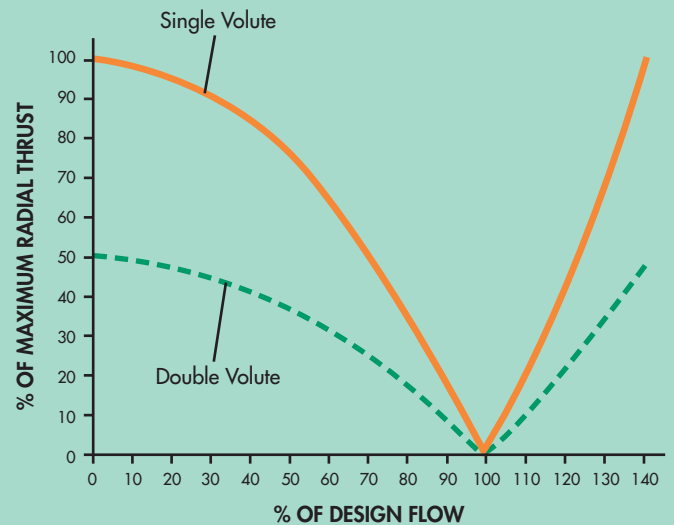

## MATERIALS OF CONSTRUCTION

COMPONENT	MATERIALS
Casing	VR-1, VR-1 BPO-DMA, VR-1A, VR-1V, EY-2
Impeller	VR-1, VR-1 BPO-DMA, VR-1A, VR-1V, EY-2
Cover	VR-1, VR-1 BPO-DMA, VR-1A, VR-1V, EY-2
Gland	VR-1, VR-1 BPO-DMA, EY-2
Shaft	303SS (Optional 316SS)
Bearing Hsg.	Polyester Thermosetting Powder Coated Iron
Adapter	Polyester Thermosetting Powder Coated Iron
Hardware	303SS (Optional hardware is available)
O-Rings	Viton A (Optional elastomers are available)

Consult Factory for materials availability for your specific pump size.

## INTEGRAL IMPELLER AND SLEEVE

- “ONE-PIECE” impeller and shaft sleeve
- “NO” shaft sleeve o-rings required
- Semi-open type with pump-out vanes and balance holes designed to minimize axial unbalance and lower stuffing box pressure



## MECHANICAL SEAL ARRANGEMENTS

Fybroc Series 1500 pumps are available with a wide variety of mechanical seal arrangements. For corrosive fluid handling, single outside and double inside seals are recommended. The single outside seals have non-metallic wetted parts and all metal components located outside the pump. The double inside mechanical seals have metallic parts that are exposed to buffer fluid only and are designed to limit the process fluid contact to non-metallic components.

The following illustrations outline some commonly used sealing arrangements. See page 8 for seal flush considerations. Additional mechanical seal configurations (for example, cartridge designs) are available as options.

**CRANE 8B2**

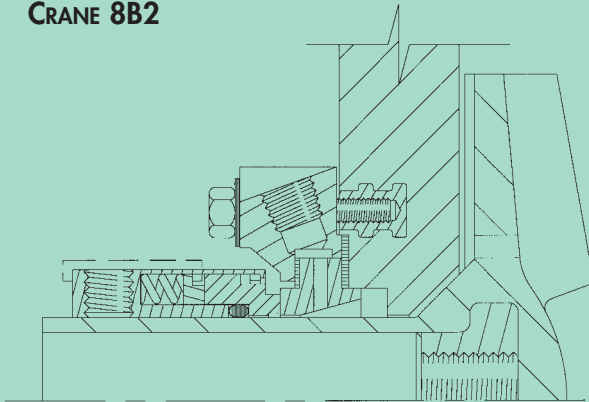

**FLOWSERVE RAC**

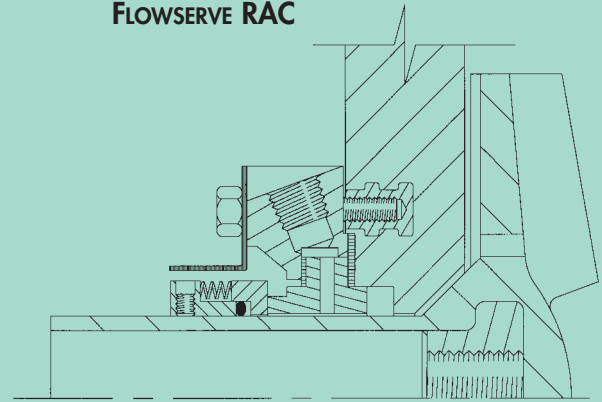

**CRANE TYPE 8-1T**

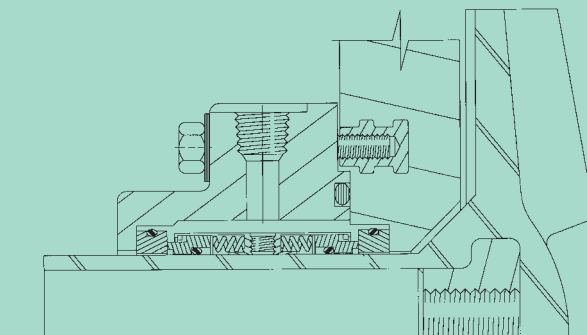

**FLOWSERVE RXO**

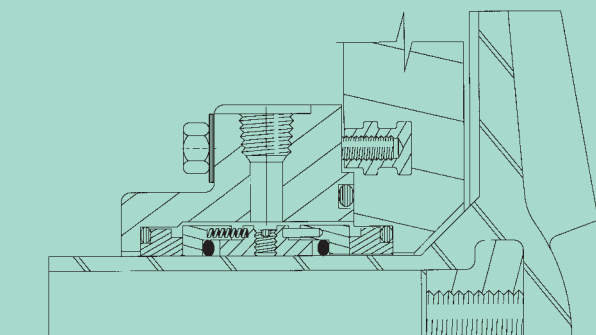

# SEAL FLUSHING ARRANGEMENTS

All mechanical seals require flushing to lubricate the seal faces and maintain normal operating temperatures. Seals are normally flushed with either a clean external fluid or by the liquid being pumped. Fybroc Series 1500 pumps are furnished, as standard, with tapped glands for connection to the flush liquid or with the optional configurations shown below.

## INTERNAL COVER FLUSH

Fybroc's Internal Cover Flush option eliminates the need for external flushing of single mechanical seals from the pump discharge, which also eliminates the possible breakage of external tubing and fittings.

This option removes seal heat by circulating high pressure liquid internally through the drilled cover to the seal chamber and then recirculating this liquid back to the low pressure side of the pump.

## FYBROC'S OPTIONAL FLUSH ASSEMBLY PACKAGE

The flush assembly\* consists of the following items:

- 1) Shut off valve and pressure gauge mounted on epoxy-coated steel bracket. Inlet side.
- 2) Solenoid valve and flow meter/metering valve mounted on epoxy-coated steel bracket. Outlet side.
- 3) Necessary tubing and fittings to pipe system to seal gland.

\*Note: The assembly is intended for use on pumps with double inside mechanical seals (Crane 8-1T, Flowserve RXO). Consult Factory for additional "special" configurations.

The system is designed to operate as follows:

- 1) Flush water is brought to the inlet side of the system and piped away to a suitable drain on the outlet side.
- 2) The normally closed solenoid valve is wired into the motor starter controls and opens when the motor is energized.
- 3) The inlet shut-off valve would remain open at all times and would be used only when the system needed to be isolated for maintenance purposes.
- 4) The flow meter/metering valve would be adjusted as necessary to obtain a reading of  $1/4$  -  $1/2$  GPM.

When properly installed and operated as referenced above, the flush system will ensure that the mechanical seal is operating in the proper environment and is being cooled and lubricated as required.

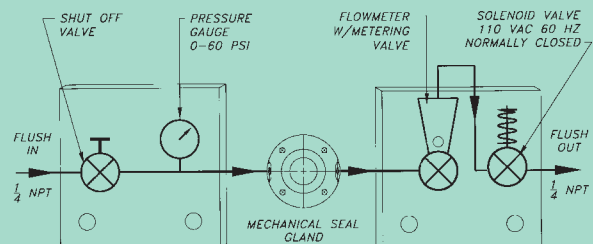
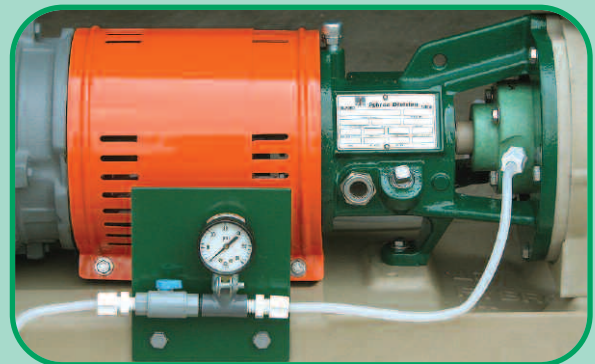
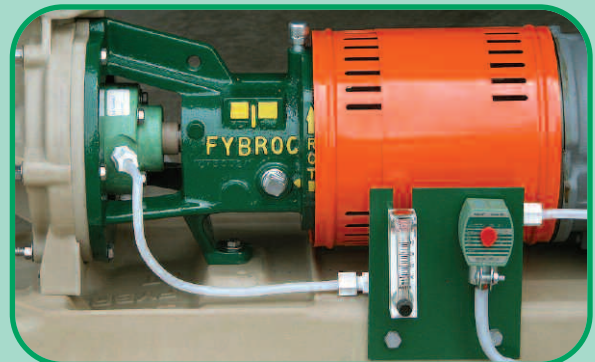
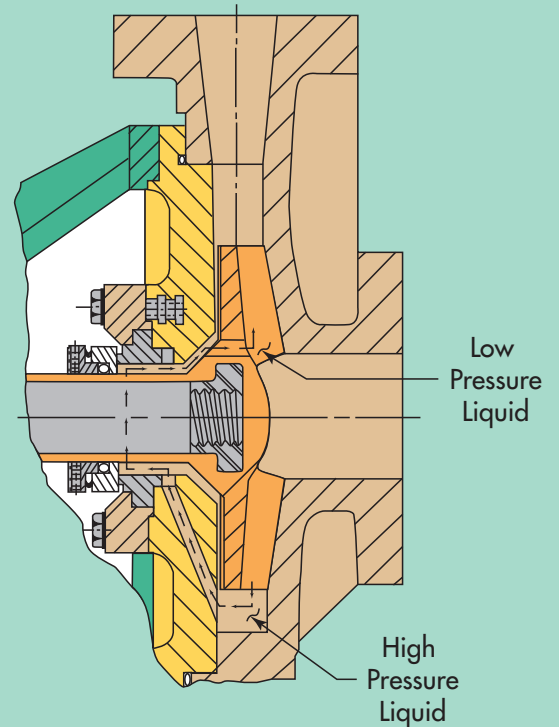



# ENGINEERING INFORMATION – SERIES 1500

PUMP IMPELLER DIAMETER X SUCTION X DISCHARGE		1 x 1.5 x 6	1.5 x 3 x 6	2 x 3 x 6	1 x 1.5 x 8	1.5 x 3 x 8	2 x 3 x 8	3 x 4 x 8	1 x 2 x 10	1.5 x 3 x 10	2 x 3 x 10	3 x 4 x 10	4 x 4 x 10	4 x 6 x 10	2 x 3 x 13	3 x 4 x 13	4 x 6 x 13	6 x 8 x 13	8 x 10 x 15	10 x 12 x 16	
ANSI DESIGNATION		AA	AB	-	AA	A50	A60	A70	A05	A50	A60	A70	-	A80	A30	A40	A80	A90	A120	-	
MAX. SPHERE SIZE		.375 (9.53)	.500 (12.70)		.313 (7.95)	.625 (15.90)	1.000 (25.40)	.188 (4.78)		.375 (9.53)	.625 (15.90)	.750 (19.05)	1.000 (25.40)	.313 (7.95)	.500 (12.70)	1.000 (25.40)	1.125 (28.60)	1.750 (44.45)	1.375 (35.00)		
CASING DATA	IMPELLER CLEARANCE	FRONT	.015 (.38)			.020 (.51)			.025 (.64)												
		BACK	.045 (1.04)			.040 (1.02)			.035 (.89)												
	CASING THICKNESS (MIN)	.500 (12.70)			.750 (19.05)	.625 (15.90)		.75 (19.05)	.625 (15.90)		1.125 (28.60)		.750 (19.05)		1.250 (31.75)		1.375 (35.00)				
	VOLUTE	SINGLE					DOUBLE	SINGLE	DOUBLE				SINGLE	DOUBLE							
SHAFT AND BEARING DATA	DIA. AT IMPELLER	.750 (19.05)			1.250 (31.75)											1.500 (38.10)					
	DIA. UNDER SLEEVE	1.125 (28.60)			1.750 (44.45)											2.500 (63.50)					
	DIA. AT BEARINGS IB/OB	1.375/1.375 (35.00/35.00)			1.968/1.771 (50.00/45.00)											2.755/2.755 (70.00/70.00)					
	DIA. BETWEEN BEARINGS	1.625 (41.30)			2.250 (57.15)											3.250 (82.55)					
	BEARING SPAN	3.790 (96.30)			7.090 (180.10)											10.250 (260.35)					
	DIA. AT COUPLING	.875 (22.22)			1.125 (28.60)											2.375 (60.32)					
	BEARING NO. INBOARD	307MZC3			310MZC3											6314ZC3					
	BEARING NO. OUTBOARD	5207AZC3			5309EZC3											5314ZC3					
	MAX. SHAFT HP (KW) PER 100 RPM	1.14 (.85 KW)			4.00 (2.98 KW)											14.80 (11.04 KW)					
	L-10 LIFE	MINIMUM 3 YEARS (26,280 HOURS)																			
	L <sup>3</sup> /D <sup>4</sup> *	152			46											32					
	BEARING FRAME GROUP	I			II											III					
	OIL CAPACITY, PINTS (L)	.375 (.18 L)			2.000 (.95 L)											5.000 (2.37 L)					
BOX DATA	SLEEVE (O.D.)	1.375 (35.00)			2.125 (54.00)											2.875 (73.00)					
	STUFFING BOX BORE	2.000 (50.80)			2.875 (73.02)											3.750 (95.25)					
	MAX. DEPTH OF BOX	2.750 (69.85)			3.250 (82.55)											3.500 (88.90)					
	PACKING SIZE	5/16 x 5/16 (7.94 x 7.94)			3/8 x 3/8 (9.52 x 9.52)											7/16 x 7/16 (11.11 x 11.11)					
	DISTANCE TO FIRST OBSTRUCTION	3.140 (79.76)			3.980 (101.10)											4.870 (123.70)					

DIMENSIONS SHOWN ARE IN INCHES AND (MILLIMETERS)

L<sup>3</sup>/D<sup>4</sup>\* – THE LOWER THE NUMBER, THE STIFFER THE SHAFT (AND THEREFORE LESS SHAFT DEFLECTION AND IMPROVED MECHANICAL SEAL LIFE).

# FYBROC SERIES 1500 – THE INDUSTRY’S MOST EXTENSIVE FIBERGLASS CORROSION-RESISTANT COVERAGE

## 1150 RPM

60 HERTZ

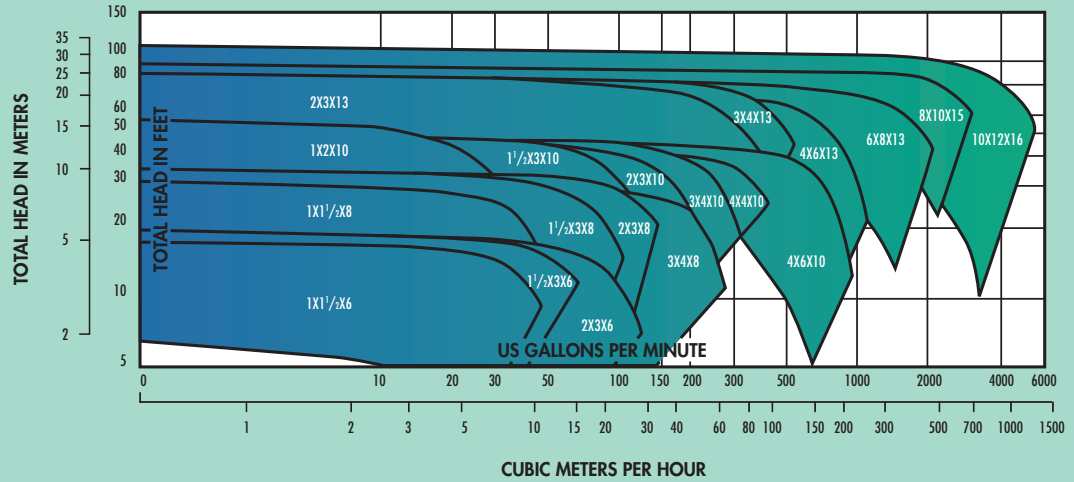

## 1750 RPM

60 HERTZ

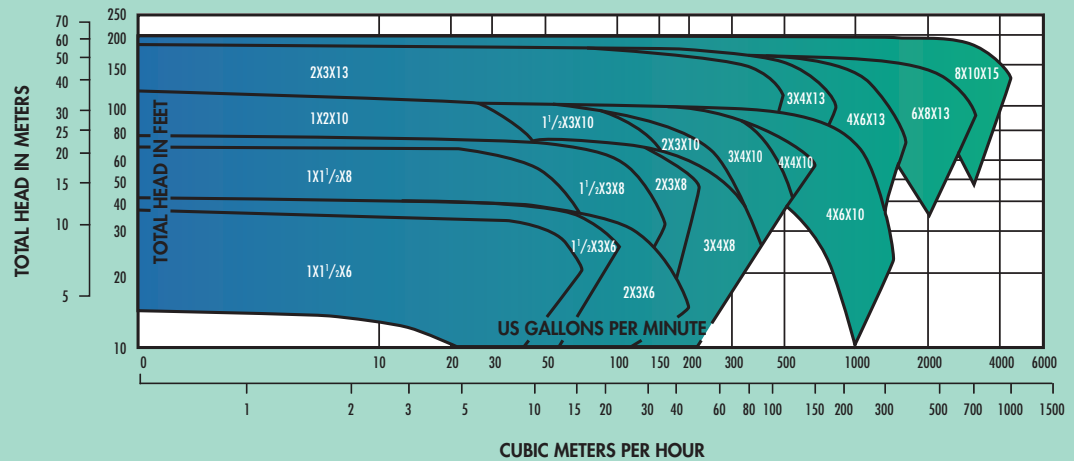

## 3500 RPM

60 HERTZ

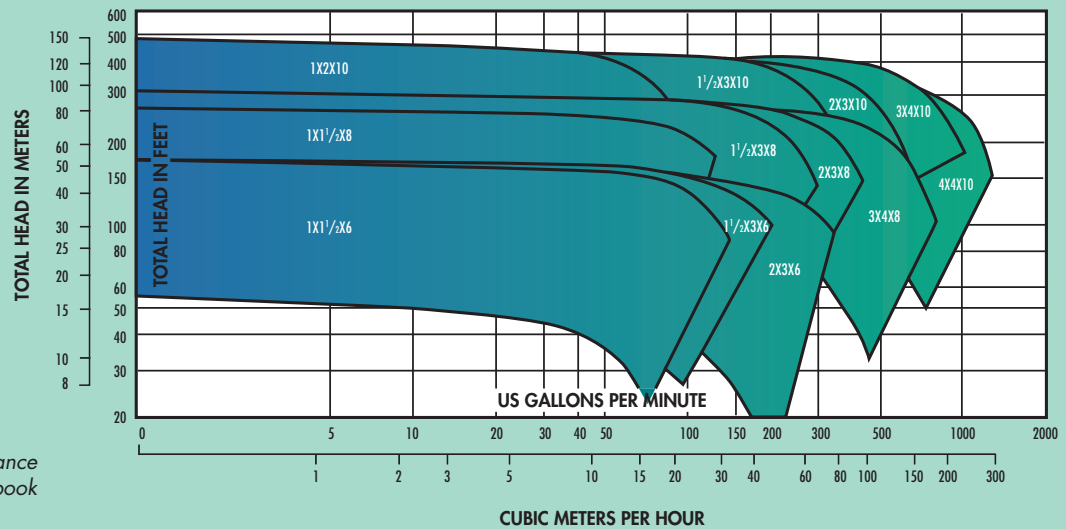

NOTE: For specific performance curves refer to curve book or [www.mp-gps.com](http://www.mp-gps.com).

**1450 RPM**

50 HERTZ

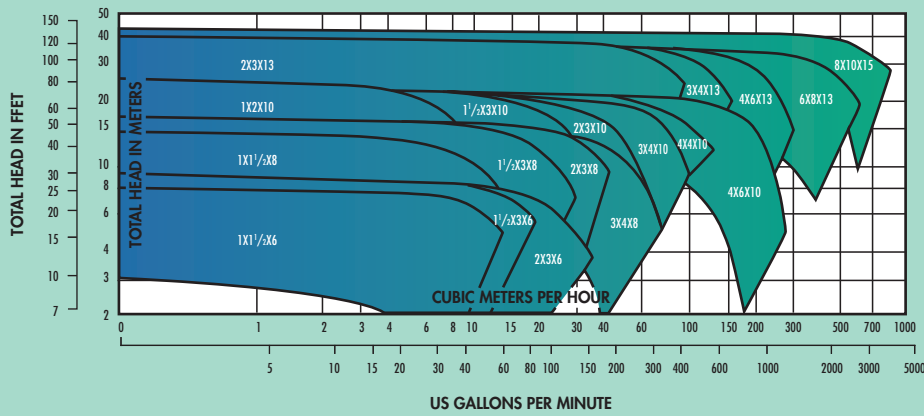

**2900 RPM**

50 HERTZ

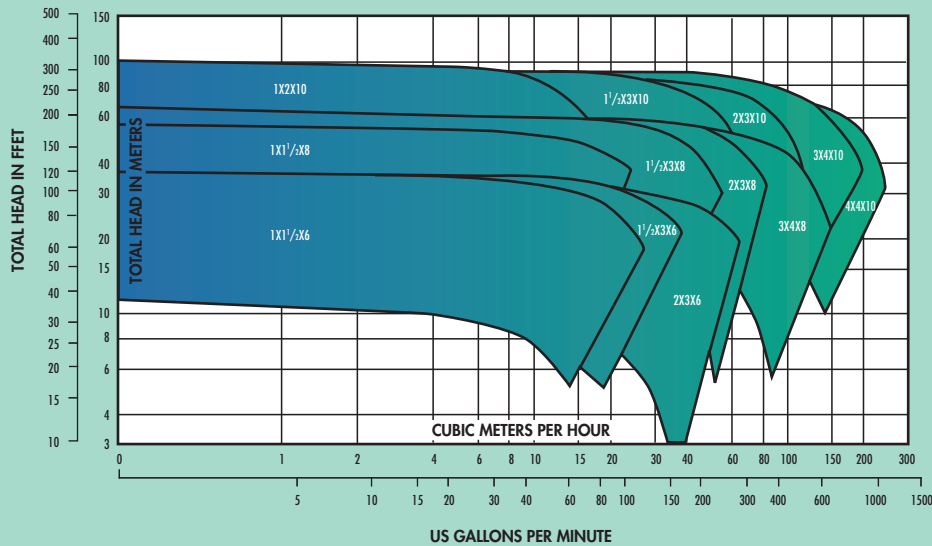

## PRESSURE-TEMPERATURE RATINGS

\* Standard flat faced flanges (ANSI/ASME B16.5 Class 150)

NOTE: Refer to Chemical Compatibility Guide for specific application ratings.

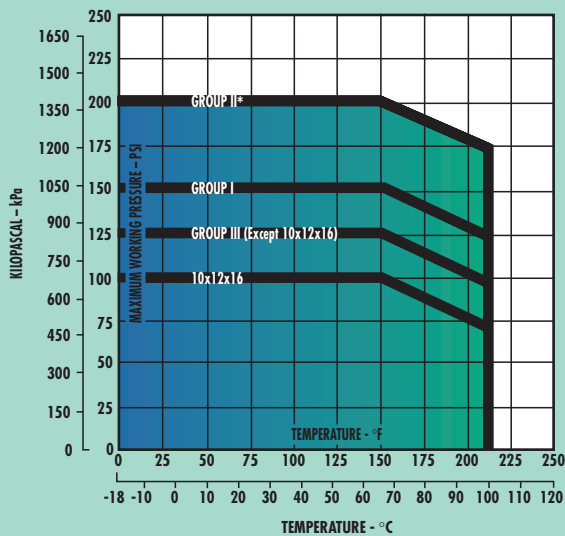

## SHAFT HORSEPOWER (KW) LIMITS

RPM	3500	2900	1750	1450	1150
Group I	40 HP (30 KW)	33 HP (25 KW)	20 HP (15 KW)	17 HP (12 KW)	13 HP (9.8 KW)
Group II	140 HP (104 KW)	116 HP (88KW)	70 HP (52 KW)	58 HP (43 KW)	46 HP (34 KW)
Group III*	—	—	260 HP (194 KW)	215 HP (160 KW)	170 HP (127 KW)

\* 1150 RPM maximum for 10x12x16

# PUMP DIMENSIONS FOR FVBROC SERIES 1500

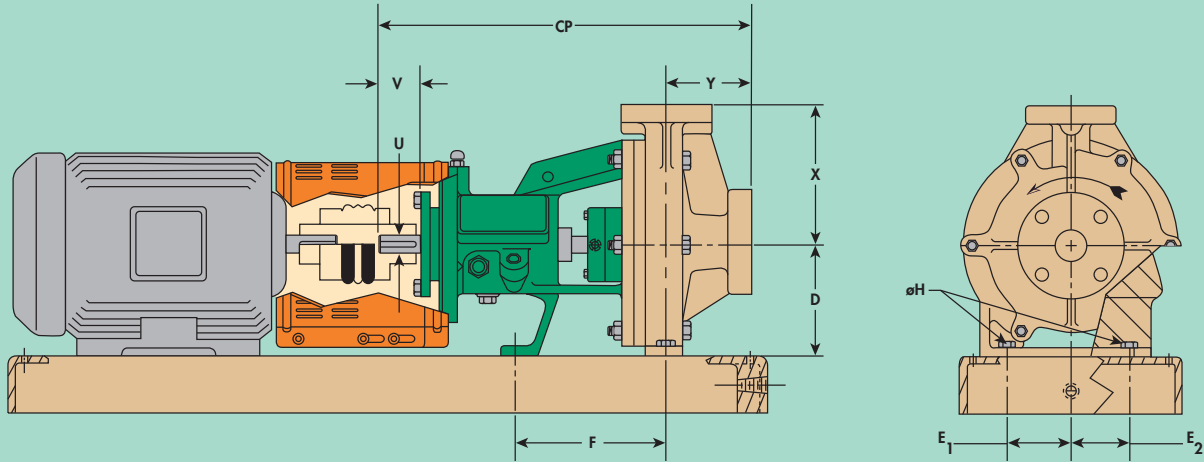

PUMP IMPELLER X SUCTION X DISCHARGE	1 x 1.5 x 6	1.5 x 3 x 6	2 x 3 x 6	1 x 1.5 x 8	1.5 x 3 x 8	2 x 3 x 8	3 x 4 x 8	1 x 2 x 10	1.5 x 3 x 10	2 x 3 x 10	3 x 4 x 10	4 x 4 x 10	4 x 6 x 10	2 x 3 x 13	3 x 4 x 13	4 x 6 x 13	6 x 8 x 13	8 x 10 x 15	10 x 12 x 16
ANSI DESIGNATION	AA	AB	-	AA	A50	A60	A70	A05	A50	A60	A70	-	A80	A30	A40	A80	A90	A120	-
ISO/DIN FLANGE AVAILABILITY	-	-	✓	-	-	✓	✓	✓	-	✓	✓	✓	✓	-	✓	✓	✓	✓	✓
JIS FLANGE AVAILABILITY	-	-	✓	-	-	✓	✓	✓	-	✓	✓	✓	✓	-	✓	✓	✓	✓	✓
CP	17 <sup>1</sup> / <sub>2</sub> (445)		23 <sup>1</sup> / <sub>2</sub> (597)										33 <sup>7</sup> / <sub>8</sub> (860)		35 <sup>1</sup> / <sub>8</sub> (892)				
D	5 <sup>1</sup> / <sub>4</sub> (133)		8 <sup>1</sup> / <sub>4</sub> (210)						10 (254)				14 <sup>1</sup> / <sub>2</sub> (368)		18 (457)				
X	6 <sup>1</sup> / <sub>2</sub> (165)		8 <sup>1</sup> / <sub>2</sub> (216)		9 <sup>1</sup> / <sub>2</sub> (242)	11 (280)	8 <sup>1</sup> / <sub>2</sub> (216)	9 <sup>1</sup> / <sub>2</sub> (242)	11 (280)	12 <sup>1</sup> / <sub>2</sub> (318)	13 <sup>1</sup> / <sub>2</sub> (343)	11 <sup>1</sup> / <sub>2</sub> (292)	12 <sup>1</sup> / <sub>2</sub> (318)	13 <sup>1</sup> / <sub>2</sub> (343)	16 (406)	19 (483)	26 (660)		
F	7 <sup>1</sup> / <sub>4</sub> (184)		12 <sup>1</sup> / <sub>2</sub> (318)										18 <sup>3</sup> / <sub>4</sub> (476)		17 <sup>3</sup> / <sub>4</sub> (541**)				
2E <sub>1</sub>	6 (152)		9 <sup>3</sup> / <sub>4</sub> (248)										16 (406)		22 (559)				
2E <sub>2</sub>	0 (0)		7 <sup>1</sup> / <sub>4</sub> (184)										9 (229)		14 (356)				
H	5 <sup>5</sup> / <sub>8</sub> (16)								7 <sup>7</sup> / <sub>8</sub> (22)				1 (25)						
U	7 <sup>7</sup> / <sub>8</sub> (22.23)		1 <sup>1</sup> / <sub>8</sub> (28.58)						2 <sup>3</sup> / <sub>8</sub> (60.33)										
KEYWAY	3 <sup>3</sup> / <sub>16</sub> x 3 <sup>3</sup> / <sub>32</sub> (4.76 x 2.38)		1 <sup>1</sup> / <sub>4</sub> x 1 <sup>1</sup> / <sub>8</sub> (6.35 x 3.18)						5 <sup>5</sup> / <sub>8</sub> x 5 <sup>5</sup> / <sub>16</sub> (15.88 x 7.94)										
V	2 (51)		2 <sup>5</sup> / <sub>8</sub> (67)						4 (102)										
Y	4 (102)								6 (152)		7 (178)								
MOTOR FRAME	143T-184T				143T-145T				254T-365T										
BASEPLATE MODEL #	1T				2				5										
MOTOR FRAME	213T-215T				182T-286T				404TS-445T										
BASEPLATE MODEL #	2T				2				6										
MOTOR FRAME	254T-256T				324T-405TS				-										
BASEPLATE MODEL #	1				3				-										

DIMENSIONS SHOWN ARE IN INCHES AND (MILLIMETERS)

\*CF—Consult Factory (FRP baseplate available up to 365T frame)

\*\*Front mounting holes 1" to rear of discharge centerline

# BASEPLATE DIMENSIONS

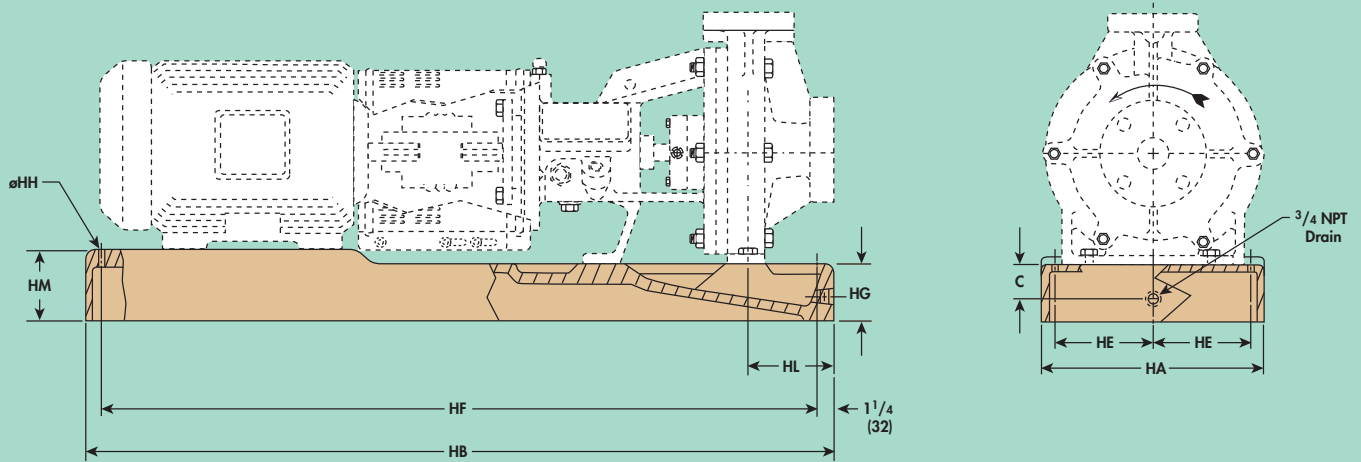

BASE PLATE MODEL	HA	HB	HE	HF	HG	HH	HL	HM	C
1T	10 (254)	35 (890)	4 (102)	32 $\frac{1}{2}$ (825)	2 $\frac{5}{8}$ (67)	$\frac{3}{4}$ (19)	4 $\frac{1}{2}$ (114)	3 $\frac{3}{8}$ (86)	1 $\frac{11}{16}$ (43)
2T	12 (305)	39 (990)	4 $\frac{1}{2}$ (114)	36 $\frac{1}{2}$ (927)	2 $\frac{7}{8}$ (73)	$\frac{3}{4}$ (19)	4 $\frac{1}{2}$ (114)	2 $\frac{7}{8}$ (73)	1 $\frac{15}{16}$ (49)
1	12 (305)	45 (1140)	4 $\frac{1}{2}$ (114)	42 $\frac{1}{2}$ (1080)	3 $\frac{3}{4}$ (95)	$\frac{3}{4}$ (19)	4 $\frac{1}{2}$ (114)	2 $\frac{3}{4}$ (70)	1 $\frac{7}{8}$ (47)
2	15 (381)	52 (1320)	6 (152)	49 $\frac{1}{2}$ (1257)	3 $\frac{3}{4}$ (95)	$\frac{3}{4}$ (19)	4 $\frac{1}{2}$ (114)	3 $\frac{3}{4}$ (95)	1 $\frac{7}{8}$ (47)
3	18 (457)	58 (1475)	7 $\frac{1}{2}$ (191)	55 $\frac{1}{2}$ (1410)	4 (102)	1 (25)	4 $\frac{1}{2}$ (114)	4 (102)	1 $\frac{7}{8}$ (47)
†4	18 (457)	60 (1525)	7 $\frac{1}{2}$ (191)	57 $\frac{1}{2}$ (1460)	4 (102)	1 (25)	*NOTE	4 (102)	N/A
5	22 (559)	68 (1727)	9 $\frac{1}{2}$ (241)	65 $\frac{1}{2}$ (1664)	4 $\frac{1}{2}$ (114)	1 (25)	6 $\frac{1}{2}$ (165)	4 $\frac{1}{2}$ (114)	1 $\frac{1}{2}$ (38)
6	22 (559)	80 (2032)	9 $\frac{1}{2}$ (241)	77 $\frac{1}{2}$ (1969)	4 $\frac{1}{2}$ (114)	1 (25)	6 $\frac{1}{2}$ (165)	4 $\frac{1}{2}$ (114)	1 $\frac{1}{2}$ (38)

DIMENSIONS SHOWN ARE IN INCHES AND (MILLIMETERS)

\*Note: Dimension varies with pump model

†Model 4 base available for special applications. Consult Factory.

Mount your pump on a corrosion-resistant fiberglass baseplate from Fyroc.

- **Corrosion resistance**

Fyroc fiberglass baseplates are designed specifically for use in corrosive environments, providing the same corrosion-resistance as our time-proven Fyroc fiberglass pumps.

- **High strength**

A high percentage of continuous-strand fiberglass mat reinforces the corrosion-resistant resin, thereby giving the baseplate an exceptional degree of strength.

- **Integral drip pan with rim construction**

Each Fyroc fiberglass baseplate incorporates an integral, sloped drip pan, eliminating expensive alloy drip pans and/or rimmed baseplates.

- **Economy**

Fyroc fiberglass baseplates resist corrosion indefinitely, thus eliminating the operational and maintenance costs of replacing corroded baseplates.

- **ANSI/ASME dimensions**

Every Fyroc fiberglass baseplate is pre-drilled to accept all ANSI/AMSE pumps and NEMA/IEC frame motors.

- **Optional Baseplate Designs**

Consult Factory for modified FRP baseplates as well as other materials such as polymer concrete (composite) and steel baseplate designs.

# OPTIONS DESIGNED TO ELIMINATE ALIGNMENT PROBLEMS

## C-FACE ADAPTER

- Available on all Fybroc Series 1500 Group I and Group II pumps
  - Group I – motor frame sizes up to 256TC
  - Group II – motor frame sizes up to 365TSC
- Designed to simplify pump/motor installation and alignment
- Reduces routine maintenance

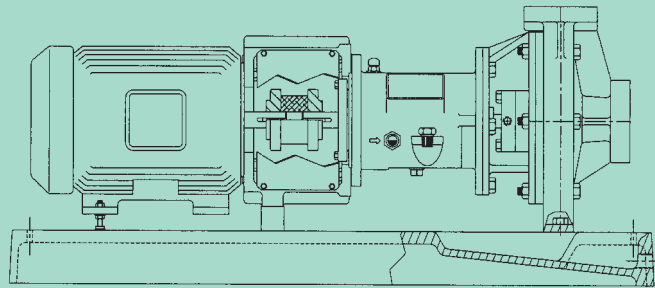
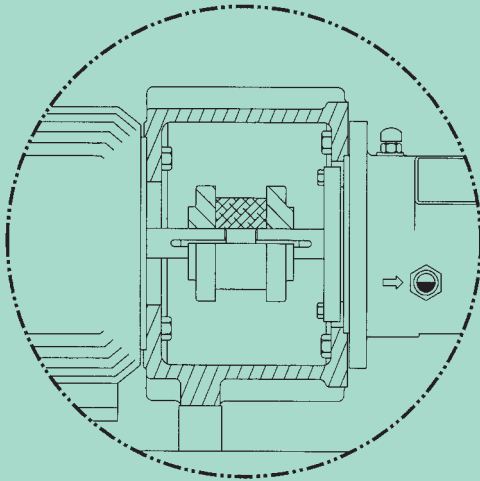

## CLOSE-COUPLED PUMPS

- Capacities to 1500 GPM (345 m<sup>3</sup>/hr)
- Heads to 400 Ft (125 m)
- C-faced JM extension motors up to 50 HP (37 KW)
- Sixteen sizes (all Fybroc Series 1500 Group I and Group II pumps)
- Available with all materials of construction (page 2)
- Available for mounting on FRP baseplates
- Lightweight/space efficient design
- Anti-spin-off device (segment key/locking ring) incorporated on the back end of the impeller sleeve to help protect against potential reverse rotation damage.

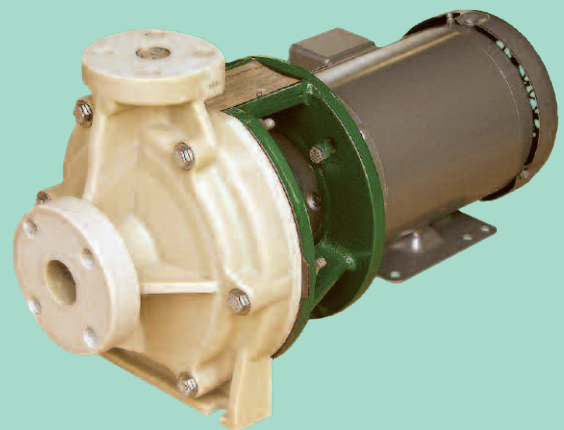

# INTERCHANGEABILITY CHARTS

EXTENSIVE INTERCHANGEABILITY SIMPLIFIES SPARE PARTS STOCKING REQUIREMENTS.

## GROUP I PUMPS

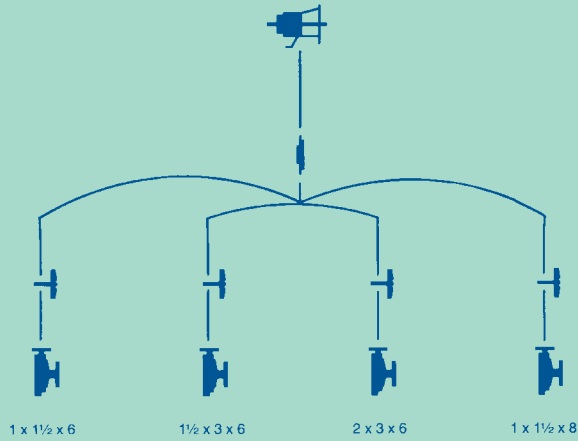

Bearing Frame

Cover

Impeller

Casing and Size

## GROUP II PUMPS

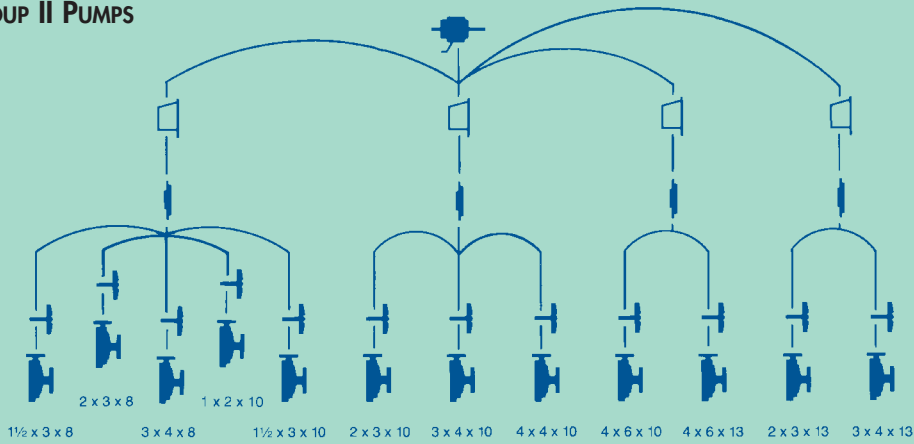

Bearing Frame

Adaptor

Cover

Impeller

Casing and Size

## GROUP II PUMPS

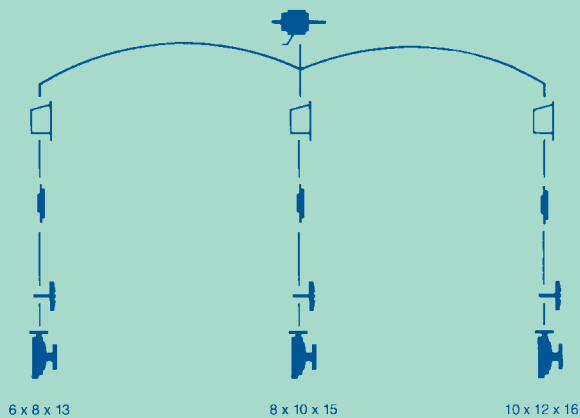

Bearing Frame

Adaptor

Cover

Impeller

Casing and Size

# EY-2 EPOXY RESIN (FRP) PUMPS

- Identical construction (thermoset) and molding process (RTM) as pumps manufactured utilizing vinyl ester resin (VR-1)
- Available in all pump configurations: centrifugal (ANSI/ASME dimensioned), close-coupled, self-priming, mag-drive, vertical sump, cantilever
- Excellent corrosion resistance with aggressive, solvent-based chemicals
- Ideal for concentrated sulfuric acid (98%)
- Higher maximum temperature capabilities, in certain applications, compared to vinyl ester resin (VR-1)
- Typical markets include pharmaceutical, petrochemical, fertilizer, and pesticide. Also, EY-2 allows expanded opportunities for Fybroc pumps in existing markets such as electronics, chemical process, and metal finishing.



## ABOUT MET-PRO GLOBAL PUMP SOLUTIONS

Met-Pro Global Pump Solutions, which combines the resources of the Company's internationally recognized Dean Pump®, Fybroc® and Sethco® brands, is a leading niche-oriented global provider of solutions and products for the pumping of corrosive, abrasive and high temperature liquids. Its broad range of high quality centrifugal pumps provide excellent performance for tough applications including pumping of acids, brines, caustics, bleaches, seawater, high temperature liquids and a wide variety of waste liquids for a broad range of applications including the chemical, petrochemical, metal finishing, wastewater treatment, desalination and aquarium/aquaculture markets. For more information, visit [www.mp-gps.com](http://www.mp-gps.com).

## ABOUT MET-PRO

Met-Pro Corporation is a global provider of solutions and products for product recovery, pollution control and fluid handling applications. The Company's products include filtration and purification equipment for air, water and harsh, corrosive applications; fluid handling equipment for water, corrosive, abrasive, and high temperature liquids; and proprietary water treatment chemicals. For more information, visit [www.met-pro.com](http://www.met-pro.com).



A Met-Pro Fluid Handling Technologies Business  
Combining the Resources of **Dean Pump, Fybroc & Sethco**

700 Emlen Way • Telford, PA 18969  
P: 215.723.8155 • TOLL-FREE: 800.FYBROC.1 • F: 215.723.2197  
info@mp-gps.com • www.mp-gps.com



© 2012 MET-PRO CORPORATION  
FYBROC® IS A REGISTERED TRADEMARK OF MET-PRO CORPORATION 07-5309 412

