

# Sure-Flex® Elastomeric Couplings (Metric)

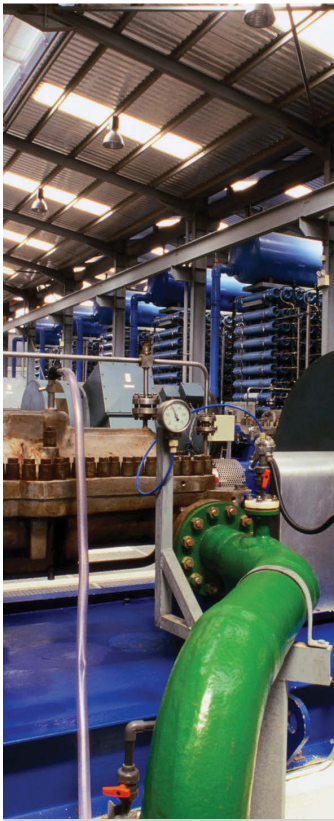

# Sure-Flex® couplings are a TB Wood's original!

Sure-Flex couplings utilize a rubber (EPDM or Neoprene) or Hytrel™ thermoplastic flex element (sleeve) to transmit torque and accommodate shaft misalignments. Sure-Flex couplings have exceptional torsional flexibility, and the 4-way flexing action absorbs virtually all types of shock, vibration, misalignment, and end float. Sure-Flex couplings are an excellent choice when low cost, high flexibility, vibration damping, and easy installation are primary concerns.



## Easy, Quick Installation

Sure-Flex can be installed quickly and easily, because there are no bolts, gaskets, covers or seals. Alignment can be checked with a straightedge placed across the outside of the precision-machined flanges. No special tools are needed for installation, alignment or removal.

## No Lubrication, Trouble-Free Operation

The teeth of the sleeve lock into the teeth of the flanges without clamps or screws, tightening under torque to provide smooth transmission of power. There is no rubbing action of metal against rubber to cause wear. Couplings are not affected by abrasives, dirt, or moisture. This eliminates the need for lubrication or maintenance, provides clean, dependable, quiet performance.



## Sure-Flex couplings last 2X to 30X longer

“Fatigue Test To Failure” results revealed that Sure-Flex coupling polymeric flex elements lasted twice as long as the nearest competitive coupling and up to 30 times longer than the remaining competitive models.



## Features (Metric)

- Up to 8.20 kNm; 72,480 in.lbs.
- Quick and easy installation
- Spacer, bushed hub, and clamping hub designs in stock
- Flexible design accommodates misalignment and protects equipment
- 7 to 15 degree torsional wind-up
- Needs no lubrication, no maintenance

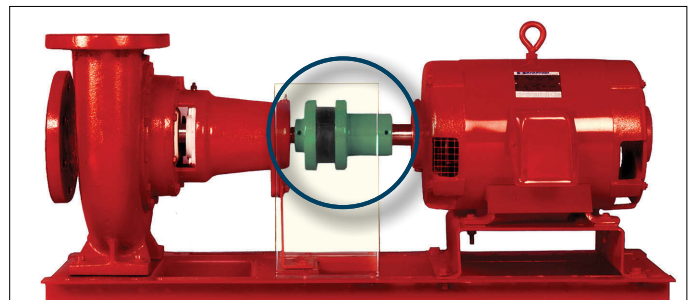

## Applications

Sure-Flex couplings can be found hard at work in many industries such as power generation and material handling. These couplings are ideal for a wide variety of applications including:

- Pumps
- Fans/Blowers
- Compressors
- Mixers
- Electric Motors
- Conveyors

**Sure-Flex 4-Way flexing action  
absorbs all types of shock, vibration and  
misalignment**



**Torsional**

Sure-Flex coupling sleeves have an exceptional ability to absorb torsional shock and dampen torsional vibrations. The EPDM and Neoprene sleeves wind-up approximately 15° torsionally at their rated torque. Hytrel sleeves will wind-up about 7°.



**Angular**

The unique design of the Sure-Flex coupling's teeth allows for the absorption of angular misalignment without wear. Refer to page 17 for actual allowable misalignment limits. These limits allow for the alignment of the coupling using only a scale and calipers.



**Parallel**

Parallel misalignment is absorbed without wear or appreciable energy losses. The lateral flexibility of the coupling sleeve minimizes radial bearing loads normally associated with parallel misalignment. This feature also allows for easier installation by the use of components bored for slip fits without fretting corrosion occurring at the shaft. Refer to page 17 for parallel misalignment limits. Only a straight-edge and feeler gage are required to obtain these limits.



**Axial**

Sure-Flex couplings may be used in applications with limited axial shaft movements. The axial compressibility of the EPDM and Neoprene sleeves allows for shaft end-float without the absolute transfer of thrust loads.

**Table of Contents**

Selection Guide	3-7
Components	3
Sleeve Selection	4
Assembly Dimensions	5
Load/Service Factor	6
Coupling Ratings	7
Type S Sure-Flex	8-9
Type J Sure-Flex	10
Type B Sure-Flex	11
Type SC Sure-Flex	12-15
Type C Sure-Flex	16
Installation Instructions	17

**Metric Version Catalog**

For Imperial information  
see Catalog P-1690-TBW

**Sure-Flex Selection Guide**

Sure-Flex couplings are selected as component parts.

1. Determine SLEEVE material and type.  
Refer to pages 4 & 5
2. Determine coupling SIZE.  
Refer to pages 6 & 7
3. Determine FLANGES to be used.  
Refer to pages 8 thru 16

Specify coupling components.

- Example #1 - Close coupled  
Size 6, Type S flange w 35 mm bore  
Size 6, Type S flange w 25 mm bore  
Size 6, Solid EPDM sleeve
- Example #2 - 5" Between shaft spacer  
Size 9, Type SC flange for #11 hub  
Size 9, Type SC flange for #9 hub  
Size 11 hub w 2-3/8" bore  
Size 9 short hub w 1-1/8" bore  
Size 9 Solid Hytrel sleeve

Prod. Number	Prod. Description
S35 mm	6S x 35 mm
6S25 mm	6S x 25 mm
6J	6JE
9SC5011	9SC50-11
9SC50	9SC50
11SCH238	11SCH x 2-3/8
9SCHS118	9SCHS x 1-1/8
9H	9H

# Selection Guide

## Sleeve Selection

Sure-Flex Sleeves are available in four materials or compounds and various shape configurations.

	EPDM	Neoprene	Hytrel	Urethane
Constructions Available				
1 pc, unsplit	JE	JN	H	U
1 pc, split	JES	JNS	—	—
2 piece	E	N	HS	—
Typical Use	General Purpose	Oil Resistant Non-Flame	General Purpose	Stiffness
Rel. Rating	1X	1X	4X	4X
Wind-Up Angular	15°	15°	7°	3°
Misalign	1°	1°	1/4°	1/4°
Temperature (C)				
maximum	+135° C	+93° C	+121° C	+93° C
minimum	-34° C	-18° C	-54° C	-62° C

## Sure-Flex Sleeves

Product No.	Product Description	Product No.	Product Description	Product No.	Product Description
3J	3JE EPDM	4	4E EPDM	6H	6H Hytrel
4J	4JE EPDM	5	5E EPDM	7H	7H Hytrel
5J	5JE EPDM	6	6E EPDM	8H	8H Hytrel
6J	6JE EPDM	7	7E EPDM	9H	9H Hytrel
7J	7JE EPDM	8	8E EPDM	10H	10H Hytrel
8J	8JE EPDM	9	9E EPDM10	11H	11H Hytrel
9J	9JE EPDM	10E EPDM11	11E EPDM	12H	12H Hytrel
10J	10JE EPDM	12	12E EPDM	6HS	6HS Split Hytrel
3JS	3JES EPDM Split	13	13E EPDM	7HS	7HS Split Hytrel
4JS	4JES EPDM Split	14	14E EPDM	8HS	8HS Split Hytrel
5JS	5JES EPDM Split	16	16E EPDM	9HS	9HS Split Hytrel
6JS	6JES EPDM Split	4N	4N Neoprene	10HS	10HS Split Hytrel
7JS	7JES EPDM Split	5N	5N Neoprene	11HS	11HS Split Hytrel
8JS	8JES EPDM Split	6N	6N Neoprene	12HS	12HS Split Hytrel
9JS	9JES EPDM Split	7N	7N Neoprene	13HS	13HS Split Hytrel
10JS	10JES EPDM Split	8N	8N Neoprene	14HS	14HS Split Hytrel
3JN	3JN Neoprene	9N	9N Neoprene	10U	10U Urethane
4JN	4JN Neoprene	10N	10N Neoprene	11U	11U Urethane
5JN	5JN Neoprene	11N	11N Neoprene	12U	12U Urethane
6JN	6JN Neoprene	12N	12N Neoprene		
7JN	7JN Neoprene	13N	13N Neoprene		
8JN	8JN Neoprene	14N	14N Neoprene		
3JNS	3JNS Neoprene Split				
4JNS	4JNS Neoprene Split				
5JNS	5JNS Neoprene Split				
6JNS	6JNS Neoprene Split				
7JNS	7JNS Neoprene Split				
8JNS	8JNS Neoprene Split				

# Selection Guide

## Assembly Dimensions

All dimensions in mm

Flexible sleeves for Wood's Sure-Flex couplings are available in four materials (EPDM, Neoprene, Hytrel and Urethane) and in three basic constructions. Characteristics of the materials are given on page 4 and the various types are shown and described here.



JE, JN

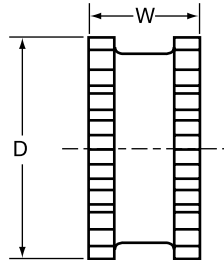

Types JES, JNS

### JE-JES-JN-JNS

J sleeves are molded EPDM rubber (E) or Neoprene (N). They are available in one-piece solid construction (JE, JN) or one-piece split construction (JES, JNS). These sleeves may be used in any Sure-Flex flange within a given size.



E and N  
(Assembled)

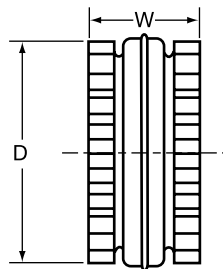

Types E and N  
(Disassembled)

### E-N

These sleeves are of two-piece design with a retaining ring. They are available in either EPDM (E) or Neoprene (N). They may be used with any flange within a given size. Sleeves are shown here assembled and disassembled.

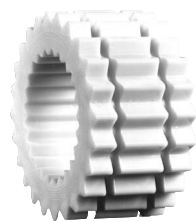

H or U

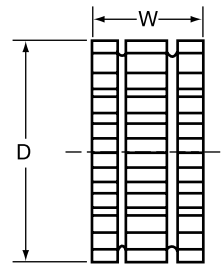

HS

### H-HS-U

H (Hytrel) and U (Urethane) sleeves, designed for high-torque applications, transmit four times as much power as an equivalent EPDM or Neoprene sleeve. Available in one-piece solid construction (H or U) or two-piece split construction (HS), these can be used only with S, C and SC flanges. They cannot be used with J or B flanges or as direct replacements for EPDM or Neoprene sleeves.

## Dimensions (mm)

Coupling Size	JE, JES, JN & JNS Sleeves EPDM & Neoprene			E and N Sleeves EPDM & Neoprene			H, U & HS Sleeves Hytrel & Urethane		
	D	W	Wt. (kgs)	D	W	Wt. (kgs)	D	W	Wt. (kgs)
3	48	25	0.03	...	...	...	...	...	...
4	75	32	0.05	75	32	0.05	...	...	...
5	75	40	0.09	75	40	0.11	...	...	...
6	95	48	0.18	95	40	0.22	95	40	0.20
7	110	55	0.28	110	55	0.35	110	55	0.31
8	129	64	0.51	129	64	0.64	129	64	0.64
9*	152	76	0.66	152	87	.095	152	76	0.82
10*	179	87	1.05	179	87	1.45	179	87	1.32
11	...	...	...	208	102	2.31	208	102	2.04
12	...	...	...	243	119	3.67	243	119	3.31
13	...	...	...	284	138	5.90	284	138	5.35
14	...	...	...	333	165	9.57	333	165	19.3
16	...	...	...	455	222	20.55	...	...	...

The 13 and 14 Hytrel available with HS sleeves only.

\*All 9J and 10J sleeves available in EPDM only.

Only sizes available in Urethane.

# Selection Guide

## 1. Select Load Symbol based on your driven machine.

Application	Load Symbol	Application	Load Symbol	Application	Load Symbol
AGITATORS—Paddle, Propeller, Screw . . . . .	L	DEWATERING SCREEN (sewage) . . . . .	M	MILLS	
BAND RESAW (lumber) . . . . .	M	DISC FEEDER . . . . .	L	Ball, Pebble, Rod, Tube, Rubber Tumbling .H	
BARGE HAUL PULLER . . . . .	H	DOUGH MIXER . . . . .	M	Dryer and Cooler . . . . .	M
BARKING (lumber) . . . . .	H	DRAW BENCH CONVEYOR and		MIXERS	
BAR SCREEN (sewage) . . . . .	L	MAIN DRIVE . . . . .	H	Concrete, Muller . . . . .	M
BATCHES (textile) . . . . .	L	DREDGES		Banbury . . . . .	H
BEATER AND PULPER (paper) . . . . .	M	Cable Reel, Pumps . . . . .	M	ORE CRUSHER . . . . .	H
BENDING ROLL (metal) . . . . .	M	Cutter Head Drive, Jig Drive, Screen Drive .H		OVEN CONVEYOR . . . . .	L
BLEACHER (paper) . . . . .	L	Maneuvering and Utility Winch, Stacker . .M		PLANER (metal or wood) . . . . .	M
BLOWERS		DYNAMOMETER . . . . .	L	PRESSES	
Centrifugal, Vane . . . . .	L	DRYERS (rotary) . . . . .	M	Brick, Briquette Machine . . . . .	H
Lobe . . . . .	M	EDGER (lumber) . . . . .	H	Notching, Paper, Punch, Printing . . . . .	M
BOTTLING MACHINERY . . . . .	L	ELEVATOR		PUG MILL . . . . .	M
BREW KETTLES (distilling) . . . . .	L	Bucket . . . . .	M	PULP GRINDER (paper) . . . . .	H
BUCKET ELEVATOR OR CONVEYOR . . . . .	M	Escalator . . . . .	L	PULVERIZERS	
CALENDERS		Freight, Passenger, Service, Man Lift . . .H		Hammerness—light duty, Roller . . . . .	M
Calender (paper) . . . . .	M	ESCALATORS . . . . .	L	Hammerness—heavy duty, Hog . . . . .	H
Calender-super (paper), Calender (rubber) .H		EXTRUDER (metal) . . . . .	H	PUMPS	
CANE KNIVES (sugar) . . . . .	M	FANS		Centrifugal, Axial . . . . .	L
CARD MACHINE (textile) . . . . .	H	Centrifugal . . . . .	L	Gear, Lobe, Vane . . . . .	M
CAR DUMPERS . . . . .	H	Cooling Tower . . . . .	H	Reciprocating—sgl. or dbl. acting,	
CAR PULLERS . . . . .	M	Forced Draft, Large Industrial or Mine . . .M		cylinder . . . . .	*
CEMENT KILN . . . . .	H	FEEDERS		REEL, REWINDER (paper) CABLE . . . . .	M
CENTRIFUGAL BLOWERS,		Apron, Belt, Disc . . . . .	L	ROD MILL . . . . .	H
COMPRESSORS, FANS or PUMPS . . . . .	L	Reciprocating . . . . .	H	SAWDUST CONVEYOR . . . . .	L
CHEMICAL FEEDERS (sewage) . . . . .	L	Screw . . . . .	M	SCREENS	
CHILLER (oil) . . . . .	M	Filter, Press-Oil . . . . .	M	Air Washing, Water . . . . .	L
CHIPPER (paper) . . . . .	H	GENERATORS		Rotary for coal or sand . . . . .	M
CIRCULAR RESAW (lumber) . . . . .	M	Uniform load . . . . .	L	Vibrating . . . . .	H
CLARIFIER or CLASSIFIER . . . . .	L	Varying load, Hoist . . . . .	M	SCREW CONVEYOR . . . . .	L
CLAY WORKING MACHINERY . . . . .	M	Welders . . . . .	H	SLAB CONVEYOR (lumber) . . . . .	M
COLLECTORS (sewage) . . . . .	L	GRIT COLLECTOR (sewage) . . . . .	L	SLITTERS (metal) . . . . .	M
COMPRESSORS		GRIZZLY . . . . .	H	SOAPERS (textile) . . . . .	L
Centrifugal . . . . .	L	HAMMERMILL		SORTING TABLE (lumber) . . . . .	M
Reciprocating . . . . .	*	Light Duty, Intermittent . . . . .	M	SPINNER (textile) . . . . .	M
Screw, Lobe . . . . .	L	Heavy Duty, Continuous . . . . .	H	STOKER . . . . .	L
CONCRETE MIXERS . . . . .	M	HOISTS		SUCTION ROLL (paper) . . . . .	M
CONVERTING MACHINE (paper) . . . . .	M	Heavy Duty . . . . .	H	TENTER FRAMES (textile) . . . . .	M
CONVEYORS		Medium Duty . . . . .	M	TIRE BUILDING MACHINES . . . . .	H
Apron, Assembly Belt, Flight, Oven, Screw .L		JORDAN (paper) . . . . .	H	TIRE & TUBE PRESS OPENER . . . . .	L
Bucket . . . . .	M	KILN, ROTARY . . . . .	H	TUMBLING BARRELS . . . . .	H
COOKERS—Brewing, Distilling, Food . . . . .	L	LAUNDRY WASHER or TUMBLER . . . . .	H	WASHER and THICKENER (paper) . . . . .	M
COOLING TOWER FANS . . . . .	H	LINE SHAFTS . . . . .	L	WINCHES . . . . .	M
COUCH (paper) . . . . .	M	LOG HAUL (lumber) . . . . .	H	WINDERS, Paper, Textile, Wire . . . . .	M
CRANES and HOISTS . . . . .	M	LOOM (textile) . . . . .	M	WINDLASS . . . . .	M
Heavy Duty Mine . . . . .	H	MACHINE TOOLS, MAIN DRIVE . . . . .	M	WIRE	
CRUSHERS—Cane (sugar), Stone or Ore . . .H		MANGLE (textile) . . . . .	L	Drawing . . . . .	H
CUTTER—Paper . . . . .	H	MASH TUBS (distilling) . . . . .	L	Winding . . . . .	M
CYLINDER (paper) . . . . .	H	MEAT GRINDER . . . . .	M	WOODWORKING MACHINERY . . . . .	L
		METAL FORMING MACHINES . . . . .	M		

\*Consult Factory

## 2. Determine Service Factor using Load Symbol and Driver

Load Symbol	L Light	M Medium	H Heavy
Standard AC Motor			
DC Shunt Motor	1.25	1.5	2.0
*Engine, 8 or more cylinders			
High Torque AC Motor			
DC Series & Comp.	1.5	2.0	2.5
*Engine, 4-6 cylinders			
*Engine, 3 cylinders or less	2.0	2.5	3.0
Turbine	1.0	1.25	1.5

\* On applications involving varying torque loads, design around the maximum load. Then determine the resulting service factor at minimum load. If this value is greater than 4.0, special coupling alignment will be required (see page 17).

**Caution:** Applications involving reciprocating engines and reciprocating driven devices are subject to rotational vibrational critical speeds which may destroy the coupling. The factory can determine these speeds when the rotational inertia (WR<sup>2</sup>) of the driveR and driveN units is known.

**3.** Use the following formula to calculate the required coupling kilowatt rating @ 100 RPM.  

$$\text{KW @ 100 RPM} = \text{KW} \times \text{Service Factor} \times 100 / \text{coupling RPM}$$

**4.** Use the chart below to find a coupling with a KW @ 100 RPM rating which is greater than calculated above.

Example: For 4 KW @ 55 RPM and 1.25 Service Factor:

$$\text{KW @ 100} = 4 \times 1.25 \times 100 / 55 = 9.09$$

Use #13 EPDM or Neoprene or #10 Hytrel with rating of 13.43 KW.

## Coupling Ratings (Metric)

Size	EPDM Sleeve	Neoprene Sleeve	KW @ RPM				Torque (Nm)	Stiffness (Nm/rad)	Max RPM
			100	970	1450	3000			
3	JE,JES	JN,JNS	0.07	0.69	1.03	2.13	6.8	26	9200
4	E,JE,JES	N,JN,JNS	0.14	1.38	2.06	4.26	13.6	52	7600
5	E,JE,JES	N,JN,JNS	0.28	2.75	4.12	8.52	27.1	104	7600
6	E,JE,JES	N,JN,JNS	0.53	5.16	7.72	15.97	50.8	194	6000
7	E,JE,JES	N,JN,JNS	0.86	8.32	12.44	25.73	82.0	313	5250
8	E,JE,JES	N,JN,JNS	1.34	13.03	19.47	40.29	128.2	490	4500
9	E,JE,JES	N	2.13	20.66	30.88	63.89	203.4	777	3750
10	E,JE,JES	N	3.40	33.00	49.32	102.05	324.8	1241	3600
11	E	N	5.36	51.99	77.72	160.79	511.8	1955	3600
12	E	N	8.52	82.63	123.52	255.57	813.5	3107	2800
13	E	N	13.43	130.26	194.72	402.87	1282.4	4898	2400
14	E	N	21.30	206.58	308.81	638.92	2033.7	7768	2200
16	E		55.91	542.28	810.63	1677.16	5338.5	20392	1500

Size	Hytrel Sleeve	Urethane Sleeve	KW @ RPM				Torque (Nm)	Stiffness (Nm/rad)	Max RPM
			100	970	1450	3000			
6	H, HS		2.13	20.66	30.88	63.89	203.4	1130	6000
7	H, HS		3.40	33.00	49.32	102.05	324.8	2260	5250
8	H, HS		5.36	51.99	77.72	160.79	511.8	3390	4500
9	H, HS		8.52	82.63	123.52	255.57	813.5	5367	3750
10	H, HS	U	13.43	130.26	194.72	402.87	1282.4	11299*	3600
11	H, HS	U	21.30	206.58	308.81	638.92	2033.7	14123*	3600
12	H, HS	U	37.27	361.52	540.42	1118.11	3559.0	25422*	2800
13	HS		55.93	542.49	810.94	1677.80	5340.6	41680	2400
14	HS		85.76	831.84	1243.48	2572.71	8189.1	67028	2200

\* Urethane values are 220000, 350000, and 600000.





# Type S Sure-Flex

## BTS - Close Coupled Applications

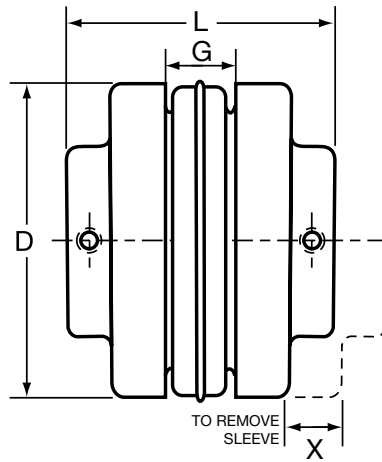

### Couplings

Type S Sure-Flex couplings are normally supplied with the two-piece E sleeve. However, any of the sleeves shown on page 5 can be used with Type S flanges.

Spacing between internal flange hubs equals L minus 2 times C. Spacing between shafts should be greater than 3.18 mm and less than L minus .85 times the sum of the two "C" dimensions.

To order complete couplings, specify coupling size with flange symbol (S) giving bore and keyseat. Refer to page 3 to order the required coupling.

Metric bore tolerance meets F7 clearance fit (ISO/R775:1969,mm)

### Dimensions

Stock Bores (mm)																Max. Bore in. (mm)		Shallow Keyseat Dimensions ② (in.)																	
14	15	16	19	20	24	25	28	30	32	35	38	42	45	48	50	52	55	60	65	70	80	90	① Standard Keyseat	② Shallow Keyseat	Bore	K.S.	Key	Bore	K.S.	Key	Bore	K.S.	Key		
X	X	X	X	X	X	X	X																	1-3/16 (30)	1-1/4 (32)	1-1/4	1/4 X 1/16	1/4 X 3/16 X 1-3/8	...	...	...	...	...	...	...
	X		X	X	X	X	X	X	X	X														1-7/16 (37)	1-1/2 (38)	...	...	...	...	...	...	...	...	...	...
																								...	1-3/4 (44)	1-1/2 & 1-5/8	3/8 X 1/8	3/8 X 5/16 X ▲	1-3/4	3/8 X 1/16	3/8 X 1/4 X 1-1/4	...	...	...	...
																								...	1-7/8 (48)	...	...	...	...	...	...	1-7/8	1/2 X 1/16	1/2 X 5/16 X 1-9/16	...
			X	X	X	X	X	X	X	X	X													1-5/8 (41)	1-7/8 (48)	1-7/8	1/2 X 1/8	1/2 X 3/8 X 1-7/8	...	...	...	...	...	...	...
				X	X	X	X	X	X	X	X	X	X											1-15/16 (49)	2-1/4 (57)	2-1/8	1/2 X 3/16	1/2 X 7/16 X 2-1/8	...	...	...	...	...	...	...
																								...	2-3/8 (60)	...	...	...	2-3/8	5/8 X 1/8	5/8 X 7/16 X 1-7/8	...	...	...	...
				X	X	X	X	X	X	X														2-1/2 (64)	2-3/4 (70)	...	...	...	...	...	...	...	...	...	...
																								...	2-7/8 (73)	2-7/8	3/4 X 1/8	3/4 X 1/2 X 2-1/4	...	...	...	...	...	...	...
								X	X	X	X	X	X	X	X	X	X	X						2-3/4 (70)	3-1/8 (79)	2-7/8	3/4 X 1/4	3/4 X 5/8 X 2-3/4	...	...	...	...	...	...	...
																								...	3-3/8 (86)	...	...	...	3-3/8	7/8 X 3/16	7/8 X 5/8 X 2-5/8	...	...	...	...
									X	X	X	X	X	X		X	X	X	X					3-3/8 (86)	3-7/16 (87)	3-7/16	7/8 X 3/16	7/8 X 5/8 X 3-7/16	...	...	...	...	...	...	...
																								...	3-7/8 (98)	3-7/8	1 X 1/4	1 X 3/4 X 3	...	...	...	...	...	...	...
															X									3-7/8 (98)	3-15/16 (100)	...	...	...	...	...	...	...	...	...	...
																								4-1/2 (114)	...	...	...	...	...	...	...	...	...	...	...
																								5 (127)	...	...	...	...	...	...	...	...	...	...	...
																								5-1/2 (140)	6 (152)	...	...	...	...	...	...	...	...	...	...

① See charts on page 11.

② Some large bore Type S flanges are supplied with shallow keyseats. In these cases, a rectangular key is furnished. The bores involved are listed above.

▲ 41mm for 38mm bore, 49mm for 41mm bore.

# Type J Sure-Flex

## BTS - Close Coupled Applications

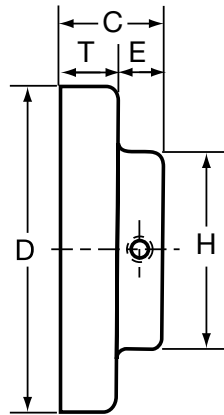

### Flanges

Type J flanges sizes 3, 4 and 5 are manufactured of sintered carbon steel. The powdered metal manufacturing process provides high dimensional accuracy and uniform material properties for high strength. Size 6 is made of high strength cast iron. All flanges are bored-to-size for a slip fit on standard shafts. The outside diameter of the flange is machined so the surface can be used to check alignment without a special tool. Type J flanges can be used with sleeves of any construction except the Hytrel. Each flange has a keyseat and two setscrews (1) over the keyway and the other at 90.

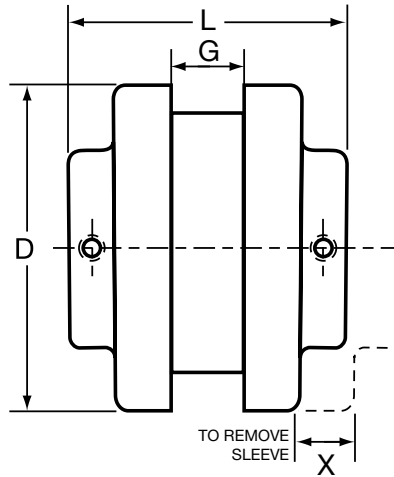

### Couplings

Type J Sure-Flex Couplings are bored-to-size. Normally, they employ the one-piece JE sleeve, or the one-piece JES sleeve with saw cut to permit replacement where there is insufficient gap between shafts.

Spacing between internal flange hubs equals G. Spacing between shafts should be greater than 3.17 mm and less than L minus .85 times the sum of the two "C" dimensions.

To order complete couplings, specify coupling size with flange symbol (J) giving bore and keyseat. Refer to page 3 to order the required coupling.

## Dimensions

Product No.	Dimensions (mm)								Wt. (kg.)	STOCK BORES*																														
	C	D	E	G	H	L	T	X		(Inches)																														
										3/8	1/2	5/8	3/4	7/8	15/16	1	1-1/8	1-3/16	1-1/4	1-3/8	Max Bore (mm)	9	11	12	14	15	16	19	20	24	25									
3J	20	52	10	10	38	50	10	16	0.14	X	X	X	X	X									7/8 (22)	...	X	X	X	X	X	X										
4J	22	63	11	16	41	60	11	16	0.18		X	X	X	X	X	X							1 (25)	...	...	...	X	X	X	X	X	X	X							
5J	27	83	12	19	48	72	15	23	0.41		X	X	X	X	X	X	X					1-1/8 (29)	...	...	...	...	...	...	...	...	...	...	...	...	...	...	...	...	...	
6J	33	102	14	22	64	89	19	28	0.54			X	X	X	X	X	X	X	X	X	X	1-3/8 (35)	...	...	...	...	...	...	...	...	...	...	...	...	...	...	...	...	...	...

\*We do not recommend reboring the 3J and 4J Flanges. See page 11 for standard keyseat dimensions and page 8 for bore tolerances.

■ Approximate weight for each flange.

# Type B Sure-Flex

## QD - Closed Coupled Applications

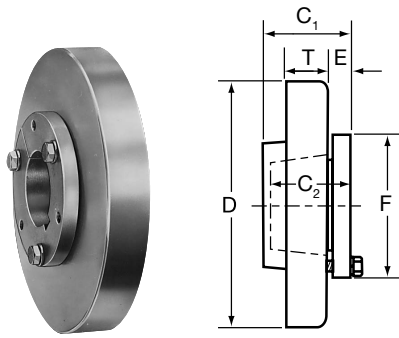

### Flanges

Type B flanges are made of high-strength cast iron the same as Types S, C and SC Sure-Flex flanges. Type B, however, is designed to accommodate Wood's Sure-Grip Bushing for easy installation and removal. All flanges drilled for "inch" series bushing.

### Bushings

Sure-Grip Bushings offer convenient mounting of the flange to the shaft securely without setscrews. They are tapered and are split through both the bushing flange and taper to provide a clamp fit, eliminating wobble, vibration and fretting corrosion. This is the same bushing used in Wood's sheaves and pulleys and is readily available everywhere.

### Dimensions (mm)

Product No.	Bushing Required	Dimensions										Max.* Bore	Weight	
		C <sub>1</sub>	C <sub>2</sub>	D	E	F	G	L	T	X	Flange		(kg.) Bushing	
6B	JA	31	25	102	12	51	22	86	20	28	32	35.56	0.36	
7B	JA	41	25	117	12	51	25	89	20	33	32	48.26	0.36	
8B	SH	48	32	138	14	68	29	103	23	28	41	73.66	0.45	
9B	SD	57	46	161	16	97	37	121	27	45	49	121.92	0.68	
10B	SK	49	48	191	18	98	41	140	31	51	64	198.12	0.91	
11B	SF	56	51	219	17	117	48	159	38	60	75	304.80	1.59	
12B	E	69	67	254	23	152	54	191	43	65	89	457.20	4.08	
13B	F	95	92	298	27	168	68	222	50	76	100	792.48	6.35	
14B	F	95	92	352	27	168	83	251	57	89	100	1305.56	6.35	
16B	J	122	114	479	32	184	121	324	70	108	114	3048.00	9.98	

\*Maximum bore with keyseat. ■ Approximate weight for each flange.

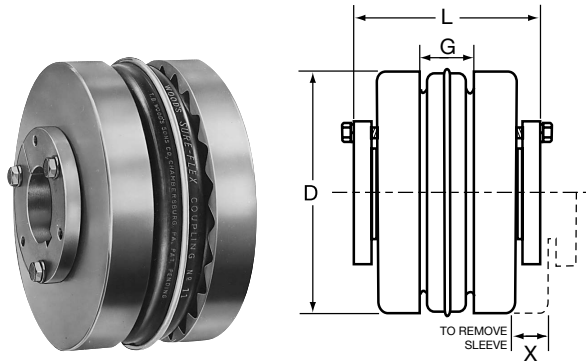

### Couplings

Type B Sure-Flex Couplings are normally supplied with the two-piece E sleeve, and can use any EPDM or Neoprene sleeves. DO NOT use Hytrel sleeves with Type B couplings

Spacing between internal flange hubs equals L minus 2 times C<sub>2</sub>. Spacing between shafts should be greater than 3.18 mm and less than G.

To order complete couplings, specify coupling size with flange symbol (B) and bushing. Refer to page 3 to order the required coupling. Refer to charts below for bushings.

### Sure-Grip® Bushing Keyseat Dimensions (mm)

Bushing	Bore	Keyseat	Bushing	Bore	Keyseat	Bushing	Bore	Keyseat
JA	15-16	5 x 5	SF	28-30	8 x 7	J	50	14 x 9
	19-20	6 x 6		32-38	10 x 8		55	16 x 10
	24-25	8 x 6*		40-42	12 x 8		60-65	18 x 11
	28	8 x 5*		45-50	14 x 9		70-75	20 x 12
SH	24-30	8 x 7		55	16 x 10		80-85	22 x 14
	32-35	10 x 8		60	18 x 11		90-95	25 x 14
SDS	24-30	8 x 7		65	18 x 8*		100	28 x 16
	32-38	10 x 8	E	35-38	10 x 8			
	40-42	12 x 8		40-42	12 x 8			
SD	24-30	8 x 7		45-50	14 x 9			
	32-38	10 x 8		55	16 x 10			
	40-42	12 x 8		60-65	18 x 11			
SK	24-30	8 x 7		70-75	20 x 12			
	32-38	10 x 8		80	22 x 11*			
	40-42	12 x 8	F	45-50	14 x 9			
	45-50	14 x 9		55	16 x 10			
	55	16 x 10		60-65	18 x 11			
				70-75	20 x 12			
				80-90	22 x 14			

\*Shallow key furnished

# Type SC Spacer Couplings

## BTS - Conventional Spacer Design

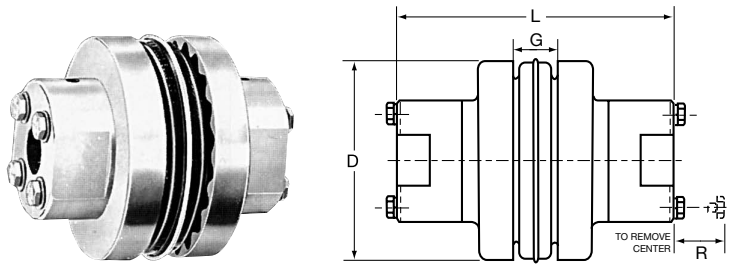

The table below shows assembled dimensions of Sure-Flex Type SC Spacer Couplings. For dimensions of separate components refer to pages 13-14.

### Flanges (mm)

Coupling Size	Required Distance Between Shafts	Use Flange No.	Use Hub No.	Max. Bore		Dimensions (mm)				Wt. (kg)
				in.	mm	D	L <sup>(2)</sup>	G	R	
4JSC	89	4JSC35	...	1-1/8	29	62	143	16	...	1.22
5SC	89	5SC35	5SCH	1-1/8	29	83	143	19	15	2.04
6SC	89	6SC35	6SCH-6SCHS	1-3/8	35	102	149	22	19	3.31
	112	6SC44	6SCH-6SCHS	1-3/8	35	102	171	22	19	3.67
7SC	127	6SC50	6SCH-6SCHS	1-3/8	35	102	187	22	19	3.95
	89	7SC35	7SCH-7SCHS	1-5/8	41	117	162	25	16	4.49
8SC	112	7SC44	7SCH-7SCHS	1-5/8	41	117	184	25	16	4.90
	127	7SC50	7SCH-7SCHS	1-5/8	41	117	200	25	16	5.17
9SC	89	8SC35	8SCH-8SCHS	1-7/8	48	138	175	29	21	6.89
	112	8SC44	8SCH-8SCHS	1-7/8	48	138	197	29	21	7.44
10SC	127	8SC50	8SCH-8SCHS	1-7/8	48	138	213	29	30	7.89
	127	8SC50-10	10SCH-10SCHS	2-3/8	60	138	244	29	30	12.34
11SC	89	9SC35	9SCH-9SCHS	2-1/8	54	161	191	37	27	8.44
	112	9SC44	9SCH-9SCHS	2-1/8	54	161	210	37	27	10.07
12SC	127	9SC50	9SCH-9SCHS	2-1/8	54	161	225	37	27	10.52
	127	9SC50-11	11SCH-11SCHS	2-7/8	73	161	264	37	30	18.33
13SC	178	9SC70-11	11SCH-11SCHS	2-7/8	73	161	314	37	30	21.86
	197	9SC78-11	11SCH-11SCHS	2-7/8	73	161	333	37	30	23.13
14SC	112	10SC48	10SCH-10SCHS	2-3/8	60	191	238	41	30	17.06
	127	10SC50	10SCH-10SCHS	2-3/8	60	191	244	41	48	17.42
15SC	178	10SC70-13	13SCH-13SCHS	3-3/8	86	191	346	41	48	32.66
	197	10SC78-13	13SCH-13SCHS	3-3/8	86	191	365	41	48	34.47
16SC	254	10SC100-13	13SCH-13SCHS	3-3/8	86	191	422	41	48	39.92
	112	11SC48	11SCH-11SCHS	2-7/8	73	219	262	48	30	24.72
17SC	127	11SC50	11SCH-11SCHS	2-7/8	73	219	264	18	30	24.81
	178	11SC70-14	14SCH	3-7/8	98	219	371	18	51	39.05
18SC	197	11SC78-14	14SCH	3-7/8	98	219	391	18	51	40.96
	254	11SC100-14	14SCH	3-7/8	98	219	448	18	51	46.58
19SC	178	12SC70	12SCH-12SCHS	2-7/8	73	254	327	59	38	39.96
	178	12SC70-14	14SCH	3-7/8	98	254	371	59	51	44.95
20SC	197	12SC78	12SCH-12SCHS	2-7/8	73	254	346	59	38	41.69
	197	12SC78-14	14SCH	3-7/8	98	254	391	59	51	46.86
21SC	254	12SC100-14	14SCH	3-7/8	98	254	448	59	51	52.48
22SC	197	13SC78	13SCH-13SCHS	3-3/8	86	248	365	68	48	58.79
23SC	197	14SC78	14SCH	3-7/8	98	352	391	83	51	81.60

■ Approximate weight for each flange.

(1) 4JSC35 x 28.58 has shallow keyseat. (2) "L" dimension and weight will change if one or two short (HS) hubs used.

Note: Refer to pages 13-14 to order — specify components separately

# Type SC Couplings and Flanges and Hubs

## Type SC Flanges and Hubs

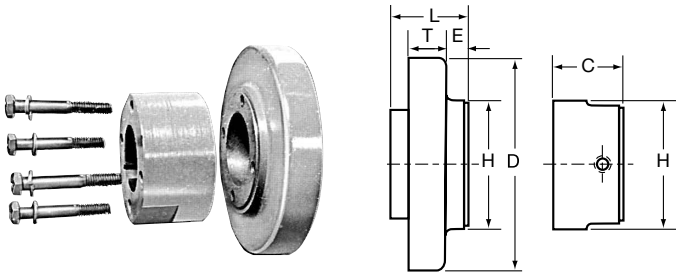

Tables on pages 13-14 provide dimensional information for flanges and hubs used for Spacer Couplings. For assembled dimensions, see table on page 12. Any of the sleeves shown on page 5 may be used.

### Flanges (mm)

Coupling Size	Flange No.	For Distance Between Shafts*	For Hub	Dimensions (mm)					Wt. (kg) ■
				D	E	H	L	T	
4JSC	4JSC35	79		62	52	51	64	11	.59
5SC	5SC35	89	5SCH	83	20	51	43	15	.59
6SC	6SC35	89	6SCH-6SCHS	102	15	64	41	18	.91
	6SC44	112	6SCH-6SCHS	102	26	64	52	18	1.90
7SC	6SC50	127	6SCH-6SCHS	102	34	64	60	18	1.23
	7SC35	89	7SCH-7SCHS	117	12	71	41	20	1.13
8SC	7SC44	112	7SCH-7SCHS	117	23	71	52	20	1.36
	7SC50	127	7SCH-7SCHS	117	31	71	60	20	1.50
9SC	8SC35	89	8SCH-8SCHS	138	7	83	41	23	1.68
	8SC35-10	89	10SCH-10SCHS	138	7	111	41	23	1.59
10SC	8SC44	112	8SCH-8SCHS	138	18	83	52	23	1.95
	8SC50	127	8SCH-8SCHS	138	26	83	60	23	2.18
11SC	8SC50-10	127	10SCH-10SCHS	138	26	111	60	23	2.50
	9SC35	89	9SCH-9SCHS	161	2	92	43	26	1.86
12SC	9SC44	112	9SCH-9SCHS	161	11	92	52	26	2.68
	9SC50	127	9SCH-9SCHS	161	19	92	60	26	2.90
13SC	9SC50-11	127	11SCH-11SCHS	161	19	133	60	26	3.18
	9SC70-11	178	11SCH-11SCHS	161	44	133	86	26	4.94
14SC	9SC78-11	197	11SCH-11SCHS	161	54	133	95	26	5.58
	10SC48	112	10SCH-10SCHS	191	9	111	57	31	4.45
15SC	10SC50	127	10SCH-10SCHS	191	12	111	60	31	4.63
	10SC70-13	178	13SCH-13SCHS	191	37	156	86	31	6.58
16SC	10SC78-13	197	13SCH-13SCHS	191	47	156	95	31	7.48
	10SC100-13	254	13SCH-13SCHS	191	50	156	124	31	10.21
17SC	11SC48	112	11SCH-11SCHS	219	1	133	38	38	5.67
	11SC50	127	11SCH-11SCHS	219	2	133	40	38	5.72
18SC	11SC70-14	178	14SCH	219	27	165	65	38	7.39
	11SC78-14	197	14SCH	219	37	165	75	38	8.35
19SC	11SC100-14	254	14SCH	219	65	165	103	38	11.16
	12SC70	178	12SCH-12SCHS	254	17	146	63	43	10.61
20SC	12SC70-14	178	14SCH	254	17	165	63	43	9.66
	12SC78	197	12SCH-12SCHS	254	26	146	72	43	11.48
21SC	12SC78-14	197	14SCH	254	26	165	72	43	10.61
	12SC100-14	254	14SCH	254	55	165	101	43	13.43
22SC	13SC78	197	13SCH-13SCHS	298	14	156	83	50	17.42
23SC	14SC78	197	14SCH	352	1	165	69	57	25.04

\*Flanges can be mixed to form different Between-Shaft Dimensions. See chart page 15. ■ Approximate weight for each flange.

▲ If using 10HS hub, 7/16-14NC x 2-1/4 long capscrew needed (not furnished).

# Type SC Couplings Flanges and Hubs

## Type SC Flanges and Hubs

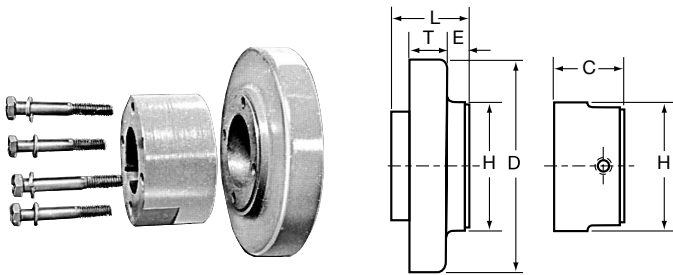

Tables on pages 13-14 provide dimensional information for flanges and hubs used for Spacer Couplings. For assembled dimensions, see table on page 12. Any of the sleeves shown on page 5 may be used.

## Hubs

Coupling Size	Hub No.	Max Bore		Stock Bores* (in)		Dimensions (mm)			Wt. (kg) ■
		in	mm	Plain Bore	Bore with Standard Keyway & SetScrew	C	H	Cap Screws Furnished (in.)	
4JSC	†	1-1/8	29	...	5/8 - 7/8 - 1 - 1-1/8*	27	51	...	...
5SC	5SCH	1-1/8	29	1/2	5/8 - 3/4 - 7/8 - 1 - 1-1/8	28	51	4-10 x 1-1/2	.363
6SC	6SCH	1-3/8	35	5/8	3/4 - 7/8 - 1 - 1-1/8 - 1-1/4 - 1-3/8	31	64	4-1/4 x 1-3/4	.635
	6SCHS	7/8	22	...	7/8	25	64	4-1/4 x 1-1/2	.499
7SC	7SCH	1-5/8	41	5/8	7/8 - 1 - 1-1/8 - 1-3/8 - 1-1/2 - 1-5/8	37	71	4-1/4 x 1-7/8	.907
	7SCHS	7/8	22	...	7/8	28	71	4-1/4 x 1-1/2	.680
8SC	8SCH	1-7/8	48	3/4	7/8 - 1 - 1-1/8 - 1-3/8	44	83	4-5/16 x 2-1/4	1.452
	8SCHS	7/8	22	...	1-1/2 - 1-5/8 - 1-3/4 - 1-7/8	31	83	4-5/16 x 1-3/4	.907
9SC	9SCH	2-1/8	54	7/8	1 - 1-1/8 - 1-3/8 - 1-1/2	50	92	4-3/8 x 2-3/4	1.905
	9SCHS	1-1/2	38	...	1-5/8 - 1-3/4 - 1-7/8 - 2-1/8	39	92	4-3/8 x 2-1/4	1.678
10SC	10SCH	2-3/8	60	1-1/8	1-5/8 - 1-7/8 - 2-1/8 - 2-3/8	60	111	4-7/16 x 3-1/4	3.357
	10SCHS	1-5/8	41	...	1-1/8	42	111	4-7/16 x 2-1/2	2.495
11SC	11SCH	2-7/8	73	1-1/8	1-7/8 - 2-1/8 - 2-3/8 - 2-7/8	69	133	4-1/2 x 3-1/2	5.534
	11SCHS	1-7/8	48	...	1-1/8 - 1-5/8	48	133	4-1/2 x 2-3/4	4.218
12SC	12SCH	2-7/8	73	1-3/8	2-1/8 - 2-3/8 - 2-7/8	75	146	4-5/8 x 4	7.530
	12SCHS	2-1/2	64	...	2-3/8	64	146	4-5/8 x 3-1/2	6.396
13SC	13SCH	3-3/8	86	1-3/8	2-3/8 - 2-7/8 - 3-3/8	85	156	4-5/8 x 4-1/2	9.027
	13SCHS	2-1/2	64	...	2-1/8 - 2-3/8	63	156	4-5/8 x 3-1/2	7.258
14SC	142SCH	3-7/8	98	1-5/8	2-3/8 - 2-7/8 - 3-3/8 - 3-7/8	98	165	4-5/8 x 5	10.977

† For 4JSC the hub is an integral part of the flange. 4JSC x 28.58 has 6.35 x 1.59 shallow key seat. ■ Approximate weight for each hub.

\* See page 8 for bore tolerances, page 11 for standard keyseat dimensions.

# Type SC Spacer Couplings

## Between Shaft Spacing

Spacer couplings are available having the most popular between shaft dimensions. Other spacings can be achieved by mixing flanges.

The "Standard" column provides spacings using identical flanges; the "Combination" column mixes flanges; the column headed "Semi-Spacer" uses one flange that is not made for spacer coupling applications and thus does not have a detachable hub.

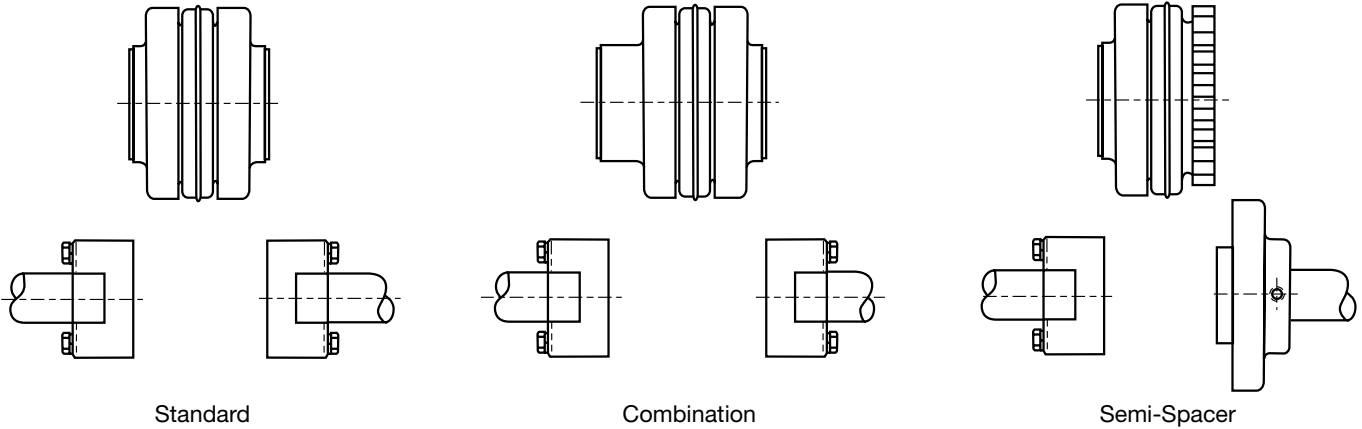

Standard (mm)	
Spacing	Uses Flanges*
80	2-( )SC35
111	2-( )SC44
127	2-( )SC50
178	2-( )SC70
197	2-( )SC78
254	2-( )SC100

Combination (mm)	
Spacing	Uses Flanges*
100	SC35 & SC44
108	SC35 & SC50
119	SC44 & SC50
133	SC35 & SC70
143	SC35 & SC78
144	SC44 & SC70
152	SC50 & SC70
154	SC44 & SC78
162	SC50 & SC78
171	SC35 & SC100**
183	SC44 & SC100**
187	SC70 & SC78
191	SC50 & SC100
216	SC70 & SC100
225	SC78 & SC100

Semi-Spacer (mm)	
Spacing	Uses Flanges*
48	S & SC35
58	S & SC44
67	S & SC50
92	S & SC70
102	S & SC78
130	S & SC100

\* Check individual coupling size for flange availability.

\*\* Non-Stock

Note: Other Combinations available — consult factory.

# Type C Sure-Flex

## Clamp Hub Spacer and Design

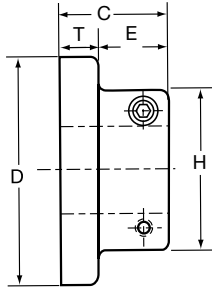

### Flanges

Sure-Flex® Type C Clamp Hub flanges employ integral locking collars and screws to assure a clamp fit on the shaft. One setscrew is furnished over the key. They are designed primarily for applications where flanges must be removed from one or both shafts without moving either the driver or driven units. A typical application is a screw compressor which uses a replaceable face seal around the input shaft.

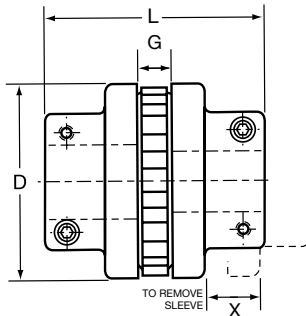
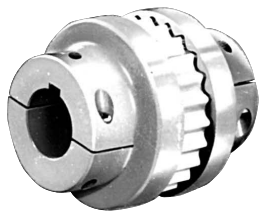

### Couplings

Type C Clamp Hub Couplings normally use Hytrel sleeves. However, any of the sleeves shown on page 5 can be used. Type C couplings may often be used where spacer couplings are required.

Spacing between internal flange hubs equals G. To order complete couplings, specify coupling size with flange symbol (C), giving bore required. Refer to page 3 to order the required coupling.

### Dimensions (mm)

Product No.	Stock Bores	Min. Bore		Maximum Bore				Distance Between Shafts		Dimensions (mm)							Approx. Weight (kg.)*
		in.	mm	Standard KS		Shallow KS		Min.	Max.	C	D	E	G	H	L	X	
				in.	mm	in.	mm										
6C	1-1/8, 1-7/8, 40mm	7/8	22	1-5/8	41	1-7/8	48	2 (51mm)	2-3/4 (70mm)	49	102	29	22	76	121	25	1.18
7C	1-3/8, 1-7/8, 35mm, 40mm	1-1/8	29	1-7/8	48	...	...	2-5/16 (59mm)	3-7/16 (87mm)	71	117	36	27	83	138	30	1063
8C	1/3/8, 1-5/8, 1-3/4, 1-7/8 2-1/8, 2-1/4, 2-3/8, 40mm	1-3/8	35	2-1/4	57	2-3/8	60	2-9/16 (65mm)	4 (102mm)	64	138	40	29	98	156	35	2.95
9C	1-5/8, 1-3/4, 1-7/8, 2, 2-1/8, 2-1/4, 2-3/8, 2-1/2	1-5/8	41	2-1/2	64	2-5/8	68	3-1/16 (78mm)	4-5/8 (117mm)	76	161	50	37	108	189	40	4.45
10C	1-5/8, 1-7/8, 2-1/4, 2-3/8, 2-1/2	1-5/8	41	2-7/8	73	...	...	3-9/16 (90mm)	5-1/4 (133mm)	89	191	58	43	127	221	46	7.53
11C	2-1/8, 2-3/8, 2-1/2	1-7/8	48	3-3/8	86	...	...	4-1/8 (105mm)	5-7/8 (149mm)	102	219	63	48	137	251	54	11.80
12C	2-1/8	1-7/8	48	3-3/8	86	...	...	4-7/8 (124mm)	6-1/2 (165mm)	111	254	68	60	152	283	60	17.37

For Standard Keyseat dimensions, see chart page 11. \*Weight of one flange.

### Bore Tolerances for Type C Flanges

These bores provide a slip fit.

Bore (in.)	Tolerance (in.)
Up to and including 2"	+ .0005 to + .0015
Over 2"	+ .0005 to + .0020

### Shallow Keyseat Dimensions

Some large bore Type C flanges are supplied with shallow keyseats. In these cases, a rectangular key is furnished. The flanges and bores involved are as follows:

Size	Bore Range	KS	Key Furnished
6C	1-11/16 to 1-7/8	1/2 x 1/16	1/2 x 5/16 x 1-15/16
8C	2-5/16 to 2-3/8	5/8 x 1/16	5/8 x 3/8 x 2-1/2
9C	2-7/16 to 2-11/16	5/8 x 3/16	5/8 x 1/2 x 3

Metric bore tolerance meets F7 clearance fit (ISO/R775:1969, mm)



# Installation Instructions

## Assembly Dimensions

All dimensions in mm

Sure-Flex flanges (outer metallic parts) and sleeves (inner elastomeric members) come in many sizes and types. First, determine the size and type of components being used. Remove all components from their boxes, and loosely assemble the coupling on any convenient surface. (Do not attempt to install the wire ring on the two-piece E or N sleeve at this time.) Also check maximum RPM values in the table against operating speed. All rubber sleeves (EPDM and Neoprene) have the same ratings for a given size and may be used interchangeably. However, because rubber and Hytrel sleeves have completely different ratings, they never should be used interchangeably.

**1.** Inspect all coupling components and remove any protective coatings or lubricants from bores, mating surfaces and fasteners. Remove any existing burrs, etc. from the shafts.

**2.** Slide one coupling flange onto each shaft, using snug-fitting keys where required. When using Type B flanges, follow the instructions furnished with the Sure-Grip bushing.

**3.** Position the flanges on the shafts to approximately achieve the Y dimension shown in the table. It is usually best to have an equal length of shaft extending into each flange. Move one flange to its final position. Torque fasteners to proper values. Slide the other flange far enough away to install the sleeve. With a two-piece sleeve, do not move the wire ring to its final position; allow it to hang loosely in the groove adjacent to the teeth.

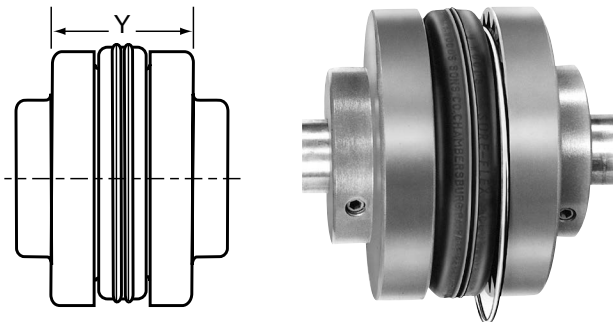

**4.** Slide the loose flange on the shaft until the sleeve is completely seated in the teeth of each flange. (The “Y” dimension is for reference and not critical.) Secure the flange to the shaft. Different coupling sleeves require different degrees of alignment precision. Locate the alignment values for your sleeve size and type in the table.

**5.** Check parallel alignment by placing a straight-edge across the two coupling flanges and measuring the maximum offset at various points around the periphery of the coupling without rotating the coupling. If the maximum offset exceeds the figure shown under “Parallel” in the table, realign the shafts.

**6.** Check angular alignment with a micrometer or caliper. Measure from the outside of one flange to the outside of the other at intervals around the periphery of the coupling. Determine the maximum and minimum dimensions without rotating the coupling. The difference between the maximum and minimum must not exceed the figure given under “Angular” in the table. If a correction is necessary, be sure to recheck the parallel alignment.

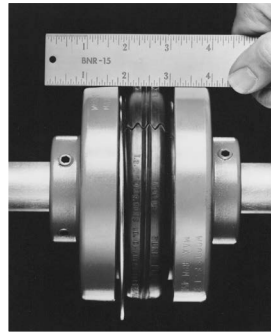

Parallel

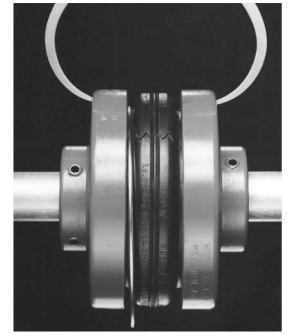

Angular

## Maximum RPM and Allowable Misalignment

Sleeve Size	Max. RPM	Types JE, JN, JES, JNS, E & N (mm)			*Type H & HS (mm)		
		Parallel	Angular	Y	Parallel	Angular	Y
3	9200	.25	.89	30.18	...	...	...
4	7600	.25	1.09	38.10	...	...	...
5	7600	.38	1.42	49.23	...	...	...
6	6000	.38	1.78	60.33	.25	.41	60.33
7	5250	.51	2.06	65.10	.31	.51	65.10
8	4500	.51	2.39	74.63	.38	.64	74.63
9	3750	.64	2.80	88.90	.43	.71	88.90
10	3600	.64	3.21	103.20	.51	.81	103.20
11	3600	.81	3.89	123.83	.56	.94	123.83
12	2800	.81	4.44	119.08	.64	1.07	144.48
13	2400	1.02	4.95	169.88	.76	1.27	168.28
14	2200	1.14	6.15	196.85	.89	1.52	196.85
16	1500	1.58	7.38	260.35	...	...	...

Note: Values shown above apply if the actual torque transmitted is more than 1/4 the coupling rating. For lesser torque, reduce the above values by 1/2.

\*Type H and HS sleeves should not be used as direct replacements for EPDM or Neoprene sleeves.

**7.** If the coupling employs the two-piece sleeve with the wire ring, force the ring into its groove in the center of the sleeve. It may be necessary to pry the ring into position with a blunt screwdriver.

**8.** Install coupling guards per OSHA requirements.

**CAUTION:** Coupling sleeves may be thrown from the coupling assembly with substantial force when the coupling is subjected to a severe shock load or abuse.

# Notes

---

---

---

---

---

---

---

---

---

---

---

---

---

---

---

---

---

---

---

---

---

---

---

---

---

---

---

# TB Wood's offers a wide range of couplings for industrial applications

For over 70 years, TB Wood's has been designing and manufacturing innovative coupling solutions to meet the requirements for a broad variety of applications spanning many industries. TB Wood's couplings represent the latest in technology, featuring superior design and exceptional quality to ensure long-lasting performance in all types of industrial applications including printing presses, machine tools, cooling tower fans, food processing equipment, pumps, blowers, electric motors, compressors, mixers, and conveyors,



## **L-Jaw** Elastomeric Couplings

Jaw-type elastomeric couplings are an economical, proven solution for general purpose applications. Jaw couplings are easy to install and require no lubrication or maintenance. Four different flexible insert types are available: Buna-N rubber, Urethane, Hytrel™ and Bronze. Jaw couplings are an excellent choice for all light and medium duty general purpose industrial applications. Models available with torque capacities up to 0.70 kNm; 6,228 in.lbs.

*See Catalog P-1686-TBW*



## **Dura-Flex** Elastomeric Couplings

Dura-Flex couplings are designed from the ground up using finite element analysis to maximize flex life. Dura-Flex couplings employ a light weight element that absorbs shock loading and torsional vibration. A flexible polyurethane material offers superior chemical, dynamic, and weathering properties. The specially designed "split-in-half flex element" moves stress away from bond, extending flex life. Dura-Flex couplings are directly interchangeable with similar couplings for fast and easy replacement. Models available with torque capacities up to 4.5 kNm; 39,500 in.lbs.

*See Catalog P-1686-TBW*

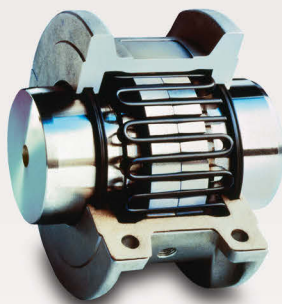

## **G-Flex** Grid Couplings

State-of-the-art design from Bibby Transmissions, the original grid coupling manufacturer. G-Flex is an all-metal coupling that provides positive protection against the damaging effects of shock loads and vibration. Aluminum horizontal cover (T10), and all-steel vertical cover (T20) designs are available. G-Flex tapered grid couplings are an excellent choice where torsional flexibility/vibration damping are primary concerns. Models available with torque capacities up to 169 kNm; 1,500,000 in.lbs.

*See Catalog P-1686-TBW*



## **Form-Flex** Disc Couplings

Form-Flex metal disc couplings consist of two hubs, a spacer and two high strength carbon or stainless steel flexible discs. Modified and special designs are commonly supplied to meet specific application conditions. Available in carbon steel, stainless steel or with corrosion resistant coatings. Models available with torque capacities up to 270 kNm; 2,400,000 in.lbs.

*See Catalog P-1686-TBW*

All Customer Service phone numbers shown in bold

## Electromagnetic Clutches and Brakes

### Warner Electric

*Electromagnetic Clutches and Brakes*

New Hartford, CT - USA  
**1-800-825-6544**

*For application assistance:*  
1-800-825-9050

St Barthelemy d'Anjou, France  
**+33 (0) 2 41 21 24 24**

*Precision Electric Coils and Electromagnetic Clutches and Brakes*

Columbia City, IN - USA  
**1-260-244-6183**

### Matrix International

*Electromagnetic Clutches and Brakes, Pressure Operated Clutches and Brakes*

Brechin, Scotland  
**+44 (0) 1356 602000**

New Hartford, CT - USA  
**1-800-825-6544**

### Inertia Dynamics

*Spring Set Brakes; Power On and Wrap Spring Clutch/Brakes*

New Hartford, CT - USA  
**1-800-800-6445**

## Linear Products

### Warner Linear

*Linear Actuators*

Belvidere, IL - USA  
**1-800-825-6544**

*For application assistance:*  
1-800-825-9050

St Barthelemy d'Anjou, France  
**+33 (0) 2 41 21 24 24**

## Couplings

### Ameridrives Couplings

*Mill Spindles, Ameriflex, Ameridisc*

Erie, PA - USA  
**1-814-480-5000**

*Gear Couplings*

San Marcos, TX - USA  
**1-800-458-0887**

### Bibby Turboflex

*Disc, Gear, Grid Couplings, Overload Clutches*

Dewsbury, England  
**+44 (0) 1924 460801**

Boksburg, South Africa  
**+27 11 918 4270**

### TB Wood's

*Elastomeric Couplings*

Chambersburg, PA - USA  
**1-888-829-6637** – Press #5

*For application assistance:*  
1-888-829-6637 – Press #7

*General Purpose Disc Couplings*

San Marcos, TX - USA  
**1-888-449-9439**

### Ameridrives Power Transmission

*Universal Joints, Drive Shafts, Mill Gear Couplings*

Green Bay, WI - USA  
**1-920-593-2444**

### Huco Dynatork

*Precision Couplings and Air Motors*

Hertford, England  
**+44 (0) 1992 501900**

Chambersburg, PA - USA  
**1-888-829-6637**

### Lamiflex Couplings

*Flexible Couplings, Bearing Isolators, and Coupling Guards*

São Paulo, SP - Brasil  
**+55-11-5679-6533**

## Heavy Duty Clutches and Brakes

### Wichita Clutch

*Pneumatic Clutches and Brakes*

Wichita Falls, TX - USA  
**1-800-964-3262**

Bedford, England  
**+44 (0) 1234 350311**

### Twiflex Limited

*Caliper Brakes and Thrusters*

Twickenham, England  
**+44 (0) 20 8894 1161**

### Industrial Clutch

*Pneumatic and Oil Immersed Clutches and Brakes*

Waukesha, WI - USA  
**1-262-547-3357**

## Gearing

### Boston Gear

*Enclosed and Open Gearing, Electrical and Mechanical P.T. Components*

Charlotte, NC - USA  
**1-800-825-6544**

*For application assistance:*  
1-800-816-5608

### Bauer Gear Motor

*Gearred Motors*

Esslingen, Germany  
**+49 (711) 3518 0**

Somerset, NJ - USA  
**1-732-469-8770**

### Nuttall Gear and Delroyd Worm Gear

*Worm Gear and Helical Speed Reducers*

Niagara Falls, NY - USA  
**1-716-298-4100**

## Overrunning Clutches

### Formsprag Clutch

*Overrunning Clutches and Holdbacks*

Warren, MI - USA  
**1-800-348-0881** – Press #1

*For application assistance:*  
1-800-348-0881 – Press #2

### Marland Clutch

*Roller Ramp and Sprag Type Overrunning Clutches and Backstops*

South Beloit, IL - USA  
**1-800-216-3515**

### Stieber Clutch

*Overrunning Clutches and Holdbacks*

Heidelberg, Germany  
**+49 (0) 6221 30 47 0**

## Belted Drives and Sheaves

### TB Wood's

*Belted Drives*

Chambersburg, PA - USA  
**1-888-829-6637** – Press #5

*For application assistance:*  
1-888-829-6637 – Press #7

## Engineered Bearing Assemblies

### Kilian Manufacturing

*Engineered Bearing Assemblies*

Syracuse, NY - USA  
**1-315-432-0700**

For information concerning our sales offices in Asia Pacific check our website [www.altramotion.com.cn](http://www.altramotion.com.cn)



[www.tbwoods.com](http://www.tbwoods.com)

440 North Fifth Avenue  
Chambersburg, PA 17201 - USA  
717-264-7161  
Fax: 717-264-6420